

LATEST PRODUCTS CORP.

P.O. BOX 190 SYOSSET, NY 11791 1-800-288-3547



2015 CATALOG



Your one-stop shop for high-quality products at the lowest prices!

Serving thousands of hospitals, nursing homes, assisted living facilities, correctional institutions, hotels, universities, commercial institutions and government agencies. These businesses count on Latest Products for quality, reliability and price savings.



LAUNDRY BAGS

HAMPERSTANDS

CART COVERS

UTILITY CARTS

PILLOWS

LINEN CARTS

PVC CARTS

HEAT DYE TRANSFERS

TRANSPORT TRUCKS

BED BUG PROTECTION

AND MUCH MORE!

WWW.LATESTPRODUCTS.NET 1-800-288-3547



For additional products not shown visit us at www.LatestProducts.net.



Bag Holders/Caddies.....	19
Bed Bug Protection.....	8
Buckets.....	68
Canvas Utility Carts.....	38, 42
Cart Covers.....	10-11
Cart Liners/Cover Caps.....	9, 39
Closed Case Carts-Stainless.....	89
Commodes.....	83-85
Dolly Trucks.....	45
Dump Trucks.....	68
Dunnage Racks.....	59-60
Emblems.....	2, 22
Extractor Trucks.....	41
Flatwork Ironer Trucks.....	41
Floor Signs.....	62
Garment Racks.....	81
Hamper Caps.....	9
Hamperstands.....	12-20
Heat Dye Transfers.....	26
Heat Sealable Patches.....	22-23
Heat Sealing Machines.....	24-25
Housekeeping & Maid Carts.....	64-67
Impervious Laundry Bags.....	5
Isolation Room Carts/Accessories.....	93
IV Poles.....	86-88
IV Transport Cart.....	46
Janitor Carts.....	64-65, 67
Laundry Bags.....	3-7, 9
Laundry Bag Accessories.....	7
Laundry Hamperstands.....	12-20
Laundry/Linen Truck Accessories.....	28
Laundry Linen Trucks.....	27-44
Laundry Net Bags.....	3
Laundry Truck Liners/Caps.....	9, 39
Lifetime Carts.....	46
Linen Exchange Carts.....	32-36
Linen Trucks-Aluminum.....	43
Linens / Basket, Replacement.....	9, 39
Lockable Wood Covered Hamper Trucks.....	42
Marking Systems.....	22
Microban Steam Caster Carts.....	52
MRI Room Hampers.....	13
Net Bags.....	3
Patches / Patching Material.....	2, 22-23
Patient Privacy Screens.....	79
Patient Room Tables.....	79
Pillows.....	21
Pillow Storage / Transport Cart.....	94
Polyethylene Multipurpose Carts.....	15, 20, 40
PVC Clean Linen Carts.....	51
PVC Hamperstands.....	18
PVC Nurse Aid Carts.....	50
Recycling Cart.....	66
Recycling Receptacles.....	69, 78, 91
Replacement Basket Liners.....	39
Round Tripper Linen Trucks.....	33-35
Scales - Laundry.....	80
Secure Document Containers.....	92
Security Units/Carts.....	32, 35-36, 47, 92
Slatbed Shelf Carts.....	45
Sheet Feed Trucks.....	41
Shelving Units.....	54-56
Shelving Accessories.....	61-63
Shower Chairs/Commodes.....	83-85
Smokers Receptacles.....	77
Spring Platforms.....	38, 42
Stem Caster Carts.....	45, 52
Step-On Cans.....	70-71, 75
Sterile Wrap Racks.....	90
Suture Carts.....	90
Tables.....	57-58, 79
Theatrical Company Carts.....	42
Trash Receptacles.....	70-77
Utility Carts.....	37-38, 40, 42, 48-49, 53
Vinyl Mattress Covers.....	8
Vinyl Utility Carts.....	38, 42
Water Soluble Laundry Bags.....	7
Wet Floor Signs.....	62
Wings.....	68

Dear Friend:

Since 1972, Latest Products Corp. has been successfully serving hospitals, nursing homes, correctional institutions and government agencies. Over the years, we continue to add new product offerings and have grown to service thousands of businesses and facilities worldwide in all types of industries. We hope you will join our many satisfied customers who rely on us for all their laundry, housekeeping and specialty item needs.

Sincerely,

The Staff at Latest Products Corp.

Just Some Of Our Latest Products...

Protect Yourself From The Bedbug Epidemic



See our Mattress & Pillow Protectors on page 8.



Go Green with our new Recycling Receptacles on pages 69, 78 & 91.

Don't forget to continuously visit our website to see our newly introduced items!!! www.LatestProducts.net

Please make sure we have your email address so we can alert you of new product offerings and our monthly specials!!!



Our Very Popular Custom Embroidered Heat-Sealable Emblem Patches



Emblems can be manufactured in up to 7 colors.

ENGINEERING DEPARTMENT

- Use on uniform sleeves or pockets to identify institution, department or name.
- Available in sizes 2" to 16"
- Standard Plastic back for sewing or heat sealable adhesive backing
- Colorfast threads
- Borders can be merrowed (spun thread) or stitched and laser cut

See Page 22 for more information



LAUNDRY MESH NET BAGS

Collect the laundry in the bag! Wash and dry it in the bag!

Return it in the Bag!

Choice of Three-Hole Rubber Closure Strap or Drawcord in Hem with Sliplock Closure. Standard color is white. Other colors available: red, blue, green, yellow, purple, orange, black, gray, pink, brown, teal. For colors, add 10%. Two color bags can be made from any of these colors at an additional 20%. Bags available with identification flags add \$4.50/dozen.



100% POLYESTER NET BAGS—STANDARD STRENGTH

STANDARD STRENGTH

SIZE	DRAWCORD	3 DZ.	6 DZ.	12 DZ.
14" x 20"	# DC 1420	\$40 DZ.	\$38 DZ.	\$36 DZ.
18" x 24"	DC 1824	42 DZ.	40 DZ.	38 DZ.
18" x 30"	DC 1830	44 DZ.	42 DZ.	40 DZ.
24" x 30"	DC 2430	54 DZ.	51 DZ.	49 DZ.
24" x 36"	DC 2436	59 DZ.	56 DZ.	54 DZ.
30" x 40"	DC 3040	70 DZ.	67 DZ.	65 DZ.

STANDARD STRENGTH

SIZE	RUBBER CLOSURE	3 DZ.	6 DZ.	12 DZ.
14" x 20"	# RC 1420	\$50 DZ.	\$47 DZ.	\$45 DZ.
18" x 24"	RC 1824	52 DZ.	50 DZ.	48 DZ.
18" x 30"	RC 1830	54 DZ.	52 DZ.	50 DZ.
24" x 30"	RC 2430	64 DZ.	61 DZ.	59 DZ.
24" x 36"	RC 2436	70 DZ.	66 DZ.	64 DZ.
30" x 40"	RC 3040	83 DZ.	77 DZ.	75 DZ.

100% POLYESTER NET BAGS—INDUSTRIAL STRENGTH

INDUSTRIAL STRENGTH

SIZE	DRAWCORD	3 DZ.	6 DZ.	12 DZ.
14" x 20"	# ID 1420	\$54 DZ.	\$51 DZ.	\$49 DZ.
18" x 24"	ID 1824	56 DZ.	53 DZ.	51 DZ.
18" x 30"	ID 1830	61 DZ.	58 DZ.	56 DZ.
24" x 30"	ID 2430	72 DZ.	69 DZ.	67 DZ.
24" x 36"	ID 2436	80 DZ.	76 DZ.	74 DZ.
30" x 40"	ID 3040	102 DZ.	97 DZ.	95 DZ.

INDUSTRIAL STRENGTH

SIZE	RUBBER CLOSURE	3 DZ.	6 DZ.	12 DZ.
14" x 20"	# IR 1420	\$66 DZ.	\$63 DZ.	\$61 DZ.
18" x 24"	IR 1824	70 DZ.	67 DZ.	65 DZ.
18" x 30"	IR 1830	74 DZ.	71 DZ.	69 DZ.
24" x 30"	IR 2430	92 DZ.	86 DZ.	84 DZ.
24" x 36"	IR 2436	94 DZ.	89 DZ.	87 DZ.
30" x 40"	IR 3040	112 DZ.	107 DZ.	105 DZ.

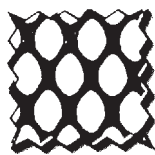

STANDARD MESH
2.3 ounces per square yard.

RAWHIDE MESH also available

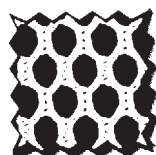

INDUSTRIAL MESH
3.50 ounces per square yard.

Industrial strength net bags used in commercial laundries can withstand high heat washers/dryers and industrial solvents. For standard strength polyester net bags, do not exceed recommended washing and drying instructions.

Colors: add 10%; sewn on identification flag: add \$4.50/dz.

Minimum order is three dozen of each size or color.
Quantity discounts available for orders over 12 dozen.
Also available with zipper closure – please inquire.
Also available with open top (no closure) – please inquire.

Call for free testing samples.



18" AND 25" LAUNDRY/HAMPER BAGS

Standard Ropeless



Flip Top Bag
18" or 25"

- Straight or round bottoms available
- Flip top features:
- Built in pocket handles at bottom
- Turn tabs under hood for easy closing
- Ropeless, flips closed just like a sandwich bag
- All stress points reinforced
- Elastic in hem

Standard Drawcord



Drawcord Bag
18" or 25"

- Drawcord features:
- Bags have drawcord and Sliplock closure
- Straight or round bottoms available

COTTON DUCK

100% natural cotton, strong and durable. Not pre-shrunk. Not recommended for wet linen. Will not rot or mildew if left wet. Color available: Natural. Color coded striping also available.

COTTON/POLYESTER BLEND

A combined fiber that provides the toughness of polyester and strength of cotton duck. Dries quicker than cotton duck. Not pre-shrunk. Colors available: Natural, Orange, Yellow, Burgundy, Red, Hunter Green, and Navy.

200 DENIER NYLON

100% nylon pre-shrunk—lightweight requiring minimal drying time. Colors available: Red, Pink, Navy Blue, Royal Blue, Powder Blue, Hunter Green, Kelly Green, Orange, Yellow, White, Black, Burgundy, and Purple. 400 denier nylon also available.



SPUN-FILAMENT POLYESTER

The blending together of spun and filament polyester yarns provides a durable, strong and non-slippery material. It is unaffected by chlorine and bleach. Highly resistant to rot, mildew and abrasion. Not pre-shrunk. A heavyweight alternative to nylon; non-absorbing. Color available: White.

BARRIER 100% POLYESTER FLUID RESISTANT LAUNDRY BAG

High density construction. Water repellent coating. Colors available: White, Yellow, Blue, Green. See pages 5-6.

IMPERVIOUS VINYL LAUNDRY BAGS

100% leakproof. Seamless bottom, electronically sealed side seams to prevent leakage. Colors available: White, Blue, Yellow, Green, Pink. See pages 5-6.

Fluid resistant bags are used to comply with OSHA's regulation which states: "Whenever contaminated laundry is wet and presents a reasonable likelihood of strike-through or leakage from the bag or container the laundry shall be placed and transported in bags or containers which prevent soak-through and leakage of fluids to the exterior."

Electronic sealing is a heat sealing process which will prevent liquids from leaking. This process is now done on all impervious vinyl laundry bags.

No representation is made that laundry bags will provide complete protection from exposure to contaminants or will eliminate the risk of contracting infectious diseases.

Don't see the laundry bag your facility currently uses? Send us a sample and we'll work up a money-saving quotation for you!

FIVE EASY WAYS TO ORDER:

1. **By Mail:** P.O. Box 190 • Syosset, NY 11791

2. **Toll-Free:** 1-800-288-3547

3. **By Fax:** 1-516-367-4714

4. **By email:** LPCORP@aol.com

5. **Through our website:** www.LatestProducts.net

LAUNDRY BAG PRICE LIST

**Ask for
Special
Pricing
On 12 Dozen
or More!**

Please be sure to specify model number and material desired.
Colors are available as well as color coding. Prices on request.

MINIMUM ORDER – 2 DOZEN

	COTTON DUCK	WHITE POLY* COTTON	200D NYLON WHITE	200D NYLON COLOR	SPUN FILAMENT POLYESTER	LEAKPROOF IMPERVIOUS VINYL	FLUID RESISTANT 100% POLYESTER
18" Diameter #1180 (18") 30" x 40" Flat Size Flip Top Straight Bottom	\$80.00 DZ	\$92.00 DZ	\$86.00 DZ	\$93.00 DZ	\$92.00 DZ	\$141.00 DZ	\$120.00 DZ
18" Diameter #1190 (18") 30" x 40" Flat Size Flip Top Round Bottom	84.00 DZ	100.00 DZ	95.00 DZ	99.00 DZ	99.00 DZ	N/A	128.00 DZ
25" Diameter #1240 (25") 40" x 40" Flat Size Flip Top Straight Bottom	91.00 DZ	102.00 DZ	95.00 DZ	103.00 DZ	105.00 DZ	152.00 DZ	134.00 DZ
25" Diameter #1250 (25") 40" x 40" Flat Size Flip Top Round Bottom	96.00 DZ	109.00 DZ	104.00 DZ	112.00 DZ	114.00 DZ	N/A	139.00 DZ
18" Diameter #13040 (18") 30" x 40" Flat Size Drawcord Straight Bottom	62.00 DZ	64.00 DZ	64.00 DZ	68.00 DZ	76.00 DZ	125.00 DZ	97.00 DZ
18" Diameter #1219 (18") 30" x 40" Flat Size Drawcord Round Bottom	71.00 DZ	72.00 DZ	74.00 DZ	77.00 DZ	84.00 DZ	N/A	107.00 DZ
25" Diameter #14040 (25") 40" x 40" Flat Size Drawcord Straight Bottom	82.00 DZ	89.00 DZ	84.00 DZ	96.00 DZ	99.00 DZ	135.00 DZ	108.00 DZ
25" Diameter #1225 (25") 40" x 40" Flat Size Drawcord Round Bottom	91.00 DZ	99.00 DZ	97.00 DZ	109.00 DZ	110.00 DZ	N/A	114.00 DZ

*For colors add \$20/dozen.

**For Polycotton, 200D Nylon, Impervious Vinyl, Fluid Resistant Polyester,
please specify color if ordering other than white.**

PLEASE NOTE: Drawcord bags can be supplied with the cord laced through grommets. The additional cost is \$24.00 per dozen bags. Please specify the proper bag number and add "GR".

Options Available: Inside or outside loops; stencilling; bio-hazard label; contamination flap; custom silk screening, and color coding stripes.

Call for free testing samples.

We can custom manufacture **any size or style** laundry bag.
Please contact us to discuss your specific requirements.

**All laundry and net bags are subject to a 25% restocking fee
for returned items for any reason except manufacturer's defects.**



SINCE 1972, DISTRIBUTORS OF SPECIALTY ITEMS FOR HOSPITALS, NURSING HOMES, INSTITUTIONS

LATEST PRODUCTS CORP.

P.O. Box 190 • Syosset, New York 11791 • 1-800-288-3547 • Fax 1-516-367-4714 • email LPCORP@aol.com

**For Use Where
Fluid Protection
is Required.**

100% Impervious Vinyl Leakproof Laundry/Hamper Bags

Ideal for diaper service companies



- Impervious Vinyl
- Leakproof
- Electronically sealed side seams to prevent leakage
- Seamless bottom
- Meets O.S.H.A. requirements
- Complies with O.S.H.A. & NFPA 701 specs, leakproof-flame retardant
- Made of washable vinyl fabric with 100% polyester knit facing
- Resists mildew
- Safely transports heavy, wet soiled linen
- Can be washed 100's of times in temperatures up to 160° F
- Elastic top for firm fit onto hamper or chair back
- 2 webbing tabs set on each side for handling
- Color stripe available

Options available: Bio-Hazard Logo, Name of Institution or Custom Marking. Minimum quantities apply.

*Due to the leakproof construction of these bags, a round bottom option is not available.

IMPERVIOUS FLIP TOP—NO DRAWCORD STRAIGHT BOTTOM*	
#3040 FTRF (#1180) 30" x 40"—18" diameter	\$141/Dozen
#4040 FTRF (#1240) 40" x 40"—25" diameter	\$152/Dozen
DRAWCORD & B-LOCK WITH STRAIGHT BOTTOM*	
#3040 RFLB (#13040) 30" x 40"—18" diameter	\$125/Dozen
#4040 RFLB (#14040) 40" x 40"—25" diameter	\$135/Dozen
Colors: White, Blue, Yellow, Green, Pink. MINIMUM ORDER 2 DOZEN	

Water and Fluid Resistant Polyester Laundry Bags

Now Available with Round Bottom!

**A less costly alternative to vinyl bags.
A low cost water and fluid resistant polyester alternative.**



Hamper above sold separately and featured on page 14.

Full line of hamperstands featured on pages 12-14 and 16-18.

- Manufactured of 100% polyester.
- High density construction.
- Seamless bottom.
- Resists fluid & bacterial penetration.
- Long-term durability.
- Laundry compatibility: high temperature and chlorine.
- Nylon cord with B-lock closure on drawcord bags.
- Elastic top for firm fit onto hamper or chair back.
- Attached webbing dump handles at bottom sides of flip top bag are standard. Drawcord models with dump handles—additional charge applies.
- Options available: bio-hazard logo, name of institution or custom marking. Minimum quantities apply.

POLYESTER FLIP TOP-STRAIGHT BOTTOM	
#3040 FTB (#1180) 30" x 40"—18" diameter	\$120/Dozen
#4040 FTB (#1240) 40" x 40"—25" diameter	\$134/Dozen
FLIP TOP-ROUND BOTTOM	
#3040 FTBR (#1190) 30" x 40"—18" diameter	\$128/Dozen
#4040 FTBR (#1250) 40" x 40"—25" diameter	\$139/Dozen
DRAWCORD & B-LOCK WITH STRAIGHT BOTTOM	
#3040 LBB (#13040) 30" x 40"—18" diameter	\$97/Dozen
#4040 LBB (#14040) 40" x 40"—25" diameter	\$108/Dozen
DRAWCORD & B-LOCK WITH ROUND BOTTOM	
#3040 LBBR (#1219) 30" x 40"—18" diameter	\$107/Dozen
#4040 LBBR (#1225) 40" x 40"—25" diameter	\$114/Dozen
Colors: White, Yellow, Blue, Green. MINIMUM ORDER 2 DOZEN	

We can make custom sizes for use by diaper service companies.

WATER SOLUBLE LAUNDRY BAGS

Ideal for Collecting and Washing Bed Bug Infested Linen



- ★ Safely Collect Contaminated Linen
- ★ Latex Free
- ★ Avoid Exposure to Germs, Blood or Infected Items
- ★ Disintegrates in Hot or Cold Water Wash

Standard Duty Hot Water Soluble — Dissolves at 140° F

Product Number	Size	Description	Units/Case	Cost per Case
O-500	26" x 33"	Isolation Standard Duty — CLEAR	100	\$ 68
O-501	26" x 33"	Isolation Standard Duty — RED	100	73
O-502	28" x 39"	Isolation Standard Duty; Fits 18" Hamper — CLEAR	100	83
O-503	28" x 39"	Isolation Standard Duty; Fits 18" Hamper — RED	100	88
O-504	36" x 39"	Isolation Standard Duty; Fits 25" Hamper — CLEAR	100	101

Heavy Duty Hot Water Soluble Clear — Dissolves at 140° F

Product Number	Size	Description	Units/Case	Cost per Case
O-508	26" x 33"	Isolation Heavy Duty	100	\$ 89
O-510	28" x 39"	Isolation Heavy Duty; Fits 18" Hamper	100	111
O-512	36" x 39"	Isolation Heavy Duty; Fits 25" Hamper	100	139

Heavy Duty Cold Water Soluble Clear

Product Number	Size	Description	Units/Case	Cost per Case
O-514	26" x 33"	Isolation Heavy Duty	100	\$ 89

Bio-Hazard in Black Print Hot Water Soluble — Dissolves at 140° F

Product Number	Size	Description	Units/Case	Cost per Case
IH019	36" x 39"	CLEAR Isolation Standard Duty; Fits 25" Hamper	100	101

Laundry Bag Accessories (sold individually)

Minimum order for accessories is 2 dozen per item with \$25 minimum.

Bio-Hazard Labels
\$2.00 each

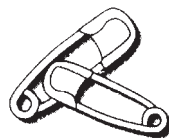

5" Nickel Plated Pins
\$2.25 each



B-Lock
65¢ each



Rubber Closure
\$1.75 each



Drawcord
60¢ each



Ball Lock
55¢ each



Handle Strap
95¢ each

Corner I.D. Flag
or
4" x 6" I.D. Flag
\$4.50 dozen

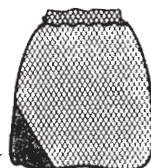

Corner I.D. Flag

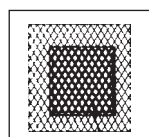

Mesh or Vinyl
5/8" Pocket
\$2.25 each

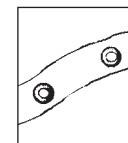

Grommets
\$2.50 each
when adhered to bag



CUSTOM COLOR STRIPE
in the Middle of Bag
\$3.50 each

Above prices refer to accessories for customizing your laundry bags.

TERMS: 2% ten days, net 30, F.O.B. Factory. We prepay shipping and add to invoice.



SINCE 1972, DISTRIBUTORS OF SPECIALTY ITEMS FOR HOSPITALS, NURSING HOMES, INSTITUTIONS

LATEST PRODUCTS CORP.

P.O. Box 190 • Syosset, New York 11791 • 1-800-288-3547 • Fax 1-516-367-4714 • email LPCORP@aol.com



BED BUG & DUST MITE PROTECTION FOR MATTRESSES AND PILLOWS

BED BUGS . . . every day you read about them in the newspaper or watch a story about them on the nightly news . . . it's a growing epidemic across the country . . .

Latest Products is very pleased to announce our complete line of **bed bug protection!**

Our products are already in use by many prominent national hospitals, nursing homes, correctional facilities, hotels/motels, and colleges across the country.



Some of the features and benefits of our products are:

- Certified Bedbug Proof with the patented BugStop® Closure
- Waterproof
- Brushed silk finish
- Treated with an anti-microbial, which inhibits the growth of mold, mildew, fungi and odor causing bacteria
- Fire retardant
- Will not crack to -15°F
- Zippered covers (recommended for maximum protection) have rust-proof polyester zippers
- Electronically sealed seams
- Special sizes available upon request including 16" deep products
- Sold in case packs only

6 GAUGE VINYL ZIPPERED MATTRESS/BOXSPRING COVERS

7" Deep

Item No.	Description	Size	Price
2006	Twin Zippered	39 x 75 x 7	\$54/case of 6
3006	Full Zippered	54 x 75 x 7	\$63/case of 6
2006-4	Hospital Twin Zippered	36 x 80 x 7	\$57/case of 6
2006-2	Long Twin Zippered	39 x 80 x 7	\$59/case of 6

6 GAUGE VINYL FITTED* MATTRESS/BOXSPRING COVERS

9" Deep

Item No.	Description	Size	Price
2996	Twin Fitted	39 x 75 x 9	\$30/case of 6
3996	Full Fitted	54 x 75 x 9	\$36/case of 6
4996	Queen Fitted	60 x 80 x 9	\$43/case of 6
5996	Cal King Fitted	72 x 84 x 9	\$50/case of 6
6996	King Fitted	78 x 80 x 9	\$50/case of 6
2996-1	Hospital Twin Fitted	36 x 80 x 9	\$33/case of 6
2996-2	Long Twin Fitted	39 x 80 x 9	\$34/case of 6
3996-1	Long Full Fitted	54 x 80 x 9	\$39/case of 6

* Fitted covers do not provide total protection.

6 GAUGE VINYL ZIPPERED MATTRESS/BOXSPRING COVERS

9" Deep

Item No.	Description	Size	Price
1606	Crib Zippered	28 x 52 x 6	\$46 per case of 6
2096	Twin Zippered	39 x 75 x 9	\$56 per case of 6
3096	Full Zippered	54 x 75 x 9	\$65 per case of 6
4096	Queen Zippered	60 x 80 x 9	\$81 per case of 6
5096	Cal King Zippered	72 x 84 x 9	\$95 per case of 6
6096	King Zippered	78 x 80 x 9	\$95 per case of 6
2096-4	Hospital Twin Zippered	36 x 80 x 9	\$59 per case of 6
2096-3	Hospital XL Twin Zippered	36 x 84 x 9	\$60 per case of 6
2096-2	Long Twin Zippered	39 x 80 x 9	\$62 per case of 6
3096-1	Long Full Zippered	54 x 80 x 9	\$68 per case of 6

6 GAUGE VINYL ZIPPERED PILLOW COVERS

Item No.	Description	Size	Price
1006	Standard Zippered	21 x 27	\$24/case of 12
1007	Queen Zippered	21 x 31	\$27/case of 12
1009	King Zippered	21 x 37	\$31/case of 12



*** BED BUG SOLUTION ELITE ***

STRETCH POLYESTER KNIT MATTRESS/BOXSPRING COVERS—9" deep

- Cool and comfortable fabric with ideal protection from bed bugs, dust mites and other allergens!
- Fluid resistant
- Breathable urethane barrier
- Machine washable

Item No.	Description	Size	Price
93680Z	Hospital Twin Zippered	36 x 80 x 9	\$388/case of 12
93975Z	Regular Twin Zippered	39 x 75 x 9	\$378/case of 12
93980Z	Long Twin Zippered	39 x 80 x 9	\$388/case of 12
95475Z	Full Zippered	54 x 75 x 9	\$453/case of 12
95480Z	Long Full Zippered	54 x 80 x 9	\$486/case of 12
96080Z	Queen Zippered	60 x 80 x 9	\$535/case of 12
97880Z	King Zippered	78 x 80 x 9	\$648/case of 12
97284Z	Cal King Zippered	72 x 84 x 9	\$648/case of 12
9220Z	Std Zippered Pillow Cover	21 x 27	\$52/case of 24
9221Z	Queen Zippered Pillow Cover	21 x 31	\$59/case of 24
9222Z	King Zippered Pillow Cover	21 x 37	\$68/case of 24



Don't see what you need? Contact us — other sizes and options available.

HAMPER CAPS

Don't Stop Using Your Old Open Hamperstands!

The Most Inexpensive Way to Convert them to Covered Stands and Comply with Joint Commission or O.S.H.A.

Made from 200 Denier Nylon with ties to fasten to frame and with elastic for snug fit.

Fits 18" - 25" Hampers

Call for free testing sample.
Washable — fits 18" - 25" Hampers
Two styles available—standard color is white—many other colors available, including Green, Red and Blue.
For colors add 10%.

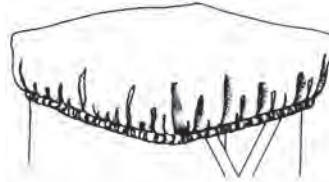

HAMPER CAP
(Lift off to load linen)

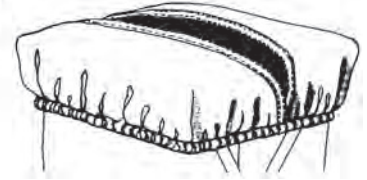

TOP-LOADING CAP
(Load linen through top slot)

Money-Saving Idea!

#18000-1 PULL-OFF CAP (NO SLOT)

2 Doz (Min) to 5 Doz\$81.00 Doz
6 Doz to 11 Doz77.00 Doz
12 Doz and More72.00 Doz

#18015-2 LOADING THROUGH SLOT

2 Doz (Min) to 5 Doz\$87.00 Doz
6 Doz to 11 Doz82.00 Doz
12 Doz and More.....77.00 Doz

SANITARY NYLON LINERS & COVERS



No. 107 NYF

NO. 107 NYF BASKET LINER
and cover flap with elastic top hem.



No. 107 NY

NO. 107 NY BASKET LINER (only)
Without flap.
Elastic in top hem.



No. 107 NYC

NO. 107 NYC NYLON CAP OR COVER (only)
With elastic in top hem keeps basket contents clean.
107NYC available in special sizes.

Designed for transport and storage of clean or soiled linen. Made of heavy duty 200-denier white nylon. Easily laundered.

BUSHEL CAPACITY	NO. 107 NY	NO. 107 NYF	NO. 107 NYC
	NYLON LINER	NYLON LINER WITH TOP FLAP	TOP COVERS OR CAPS ONLY
4	\$23.75	\$28.25	\$15.50
5	23.75	28.25	15.50
6	23.75	28.25	15.50
8	25.95	30.75	16.50
10	27.50	32.50	17.00
12	29.25	34.55	17.75
14	30.50	36.25	19.75
16	31.75	37.75	19.75
18	33.00	39.25	20.80
20	37.25	44.25	22.25

Also available: 400 Denier Nylon, Reinforced Vinyl, Water Resistant Material, Custom Colors, and Custom Sizes. Call for pricing.

CHAIR BACK LAUNDRY BAGS

Ideal for long-term patients in nursing homes or assisted living facilities.



Chairback.

15" (38 cm) diameter. Flip-top, straight bottom, no elastic in flip-top.
Flat measure: 24" x 36", bags have dump handles.

#1130

	ITEM #	PRICE PER DOZEN
Cotton Duck	1130-1	\$65.00
Poly Cotton Blend	1130-2	63.00
200 Denier Nylon (white, blue, green)	1130-3	66.00
Spun Filament Polyester	1130-4	76.00
Impervious Leakproof Vinyl (blue or white)	1130-5	82.00
Barrier Fluid Resistant (white, blue, green)	1130-6	88.00

Custom needs? Please inquire. We can manufacture to your specifications.
Samples always available.



SINCE 1972, DISTRIBUTORS OF SPECIALTY ITEMS FOR HOSPITALS, NURSING HOMES, INSTITUTIONS

LATEST PRODUCTS CORP.

P.O. Box 190 • Syosset, New York 11791 • 1-800-288-3547 • Fax 1-516-367-4714 • email LPCORP@aol.com

CART COVERS

Use on Linen Exchange Carts-Laundry Trucks to keep linen clean.

Use on Central Supply-Lab-Medicine Carts to ensure sterility.

Use on Bulk Delivery-Turnabout-Food Transport Carts
and any other cart which needs a cover.

Also ideal for covering shelving units and medical equipment.

Full Flaps, Reinforced Corners, Double Needle Construction
Choice of Heavy Duty Zippers or Velcro Closure

Choose from these materials:

200 Denier Nylon: 200 Denier nylon is a lightweight fabric used mostly in low impact applications such as storage and non-transporting carts. This fabric is both economical and consistent. Washable.

420 Denier Nylon: 420 Denier nylon is our most popular fabric for cart and shelving covers. This medium weight fabric is easy to handle, provides excellent durability, and represents a great value all around. Washable.

1000 Denier Nylon: 1000 Denier cordura nylon is used for the highest impact applications such as linen transportation carts. This rugged, heavy weight fabric is similar to that used for luggage and backpacks. Washable.

13 Ounce Reinforced Vinyl: 13 ounce vinyl fabric is most commonly used for industrial applications. This flame-retardant, OSHA approved medium weight fabric is easy to handle. Wipes clean.

#30 Easy-Grab Vinyl: Our Easy-Grab has revolutionized cart covers. With a slitted, see-through clear vinyl front, there is no need to lift a front flap. Just reach in and grab the cart or shelving unit contents such as linen, medicine or supplies. The replaceable vinyl slats wipe clean. The top, back and sides of the cover are made with your choice of 420 denier nylon, 13 ounce vinyl or #20 Staphcheck.

#20 Staphcheck: Staphcheck vinyl fabric is most commonly used in the health care industry. This is an anti-bacterial, flame-retardant, OSHA approved fabric. This medium weight fabric is easy to handle. Wipes clean.

#10 Gauge Clear See-Through Vinyl: Cover has a completely see-through front, back and sides. Wipes clean.

FOR STANDARD
SIZES AND PRICES
SEE NEXT PAGE



For sizes not listed or to verify size wanted, measure:

- ① Width: front to back ② Length: Left to right ③ Height: to top of casters

Covers are
All Double
Needle
Stitched

STANDARD CART COVER

CUSTOM EXTRAS

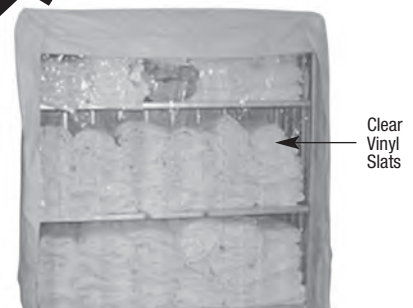
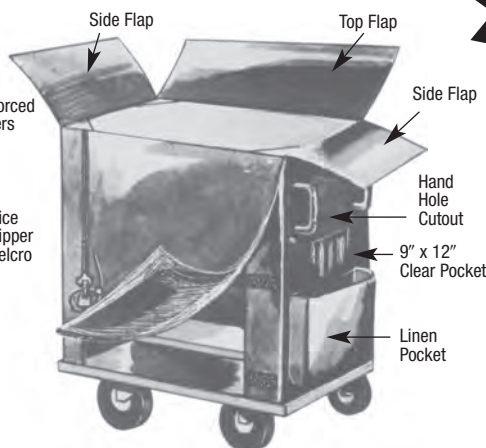
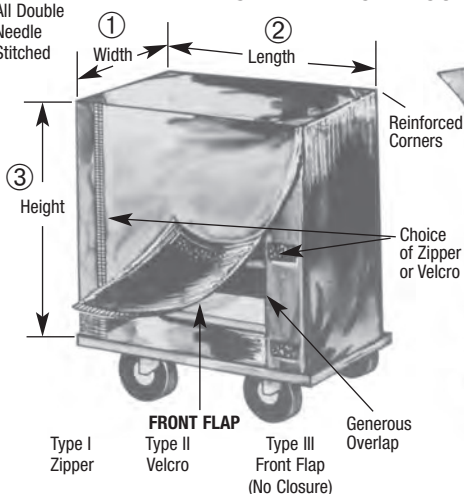

#30 Easy-Grab Cart Cover
Easy viewing and easy access to cart contents through clear vinyl slats.

All prices are F.O.B. factory

**Finest Quality
Lowest Prices**

CART COVERS

All cart covers are manufactured to your specifications.

Compare Our Prices with Others!

Did you know that Latest Products Corporation is one of the nation's largest suppliers of cart covers and shelving covers? All of our covers are custom designed to your specifications. We use reinforced corners on all covers to withstand wear and tear, and utilize either reinforced Velcro or heavy duty zippers to provide a more secure closure.

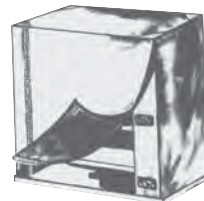

For Sizes Not Listed, Please Ask for Quote.

How to Measure Cart:
Width - Front to Back
Length - Left to Right
Height - Top of Cart to Top of Casters

Material Description	Dimensions W x L x H	Price Each		
		2*	3-5	6+
200 Denier Nylon: Durable, Washable. White, Green, Blue, Red, Yellow	18" x 48" x 52"	\$ 72.00	\$ 69.00	\$66.00
	18" x 48" x 62"	75.00	72.00	69.00
	18" x 48" x 72"	82.00	79.00	75.00
	24" x 48" x 52"	75.00	72.00	69.00
	24" x 48" x 62"	79.00	76.00	73.00
	24" x 48" x 72"	86.00	84.00	80.00
	24" x 60" x 52"	79.00	76.00	73.00
	24" x 60" x 62"	86.00	83.00	79.00
	24" x 60" x 72"	91.00	88.00	84.00
420 Denier Nylon Pack Cloth. White, Red, Hunter Green Yellow, Orange, Charcoal Gray Silver Gray, Berry, Purple, Royal Blue, Navy, Burgundy, Khaki, Black, Olive	18" x 48" x 52"	84.00	80.00	77.00
	18" x 48" x 62"	89.00	86.00	83.00
	18" x 48" x 72"	94.00	91.00	88.00
	24" x 48" x 52"	89.00	86.00	83.00
	24" x 48" x 62"	93.00	90.00	87.00
	24" x 48" x 72"	101.00	97.00	93.00
	24" x 60" x 52"	91.00	88.00	85.00
	24" x 60" x 62"	99.00	95.00	91.00
	24" x 60" x 72"	109.00	103.00	99.00
1000 Denier Nylon: Extremely Durable, Washable. White, Green, Blue, Gray	18" x 48" x 52"	97.00	93.00	90.00
	18" x 48" x 62"	102.00	98.00	95.00
	18" x 48" x 72"	106.00	101.00	97.00
	24" x 48" x 52"	101.00	97.00	93.00
	24" x 48" x 62"	107.00	102.00	98.00
	24" x 48" x 72"	110.00	106.00	102.00
	24" x 60" x 52"	108.00	103.00	100.00
	24" x 60" x 62"	113.00	109.00	106.00
	24" x 60" x 72"	116.00	112.00	109.00
13 Oz. Vinyl Reinforced: Wipes Clean. White, Green, Black, Blue, Gray, Red, Tan, Yellow	18" x 48" x 52"	94.00	91.00	88.00
	18" x 48" x 62"	99.00	95.00	91.00
	18" x 48" x 72"	107.00	102.00	98.00
	24" x 48" x 52"	99.00	95.00	91.00
	24" x 48" x 62"	106.00	101.00	97.00
	24" x 48" x 72"	116.00	112.00	108.00
	24" x 60" x 52"	106.00	101.00	97.00
	24" x 60" x 62"	112.00	108.00	103.00
	24" x 60" x 72"	121.00	117.00	113.00

Material Description	Dimensions W x L x H	Price Each		
		2*	3-5	6+
#30 Easy-Grab Vinyl with 420 Denier nylon top, back and sides. Please specify Nylon color from list to your left.	18" x 48" x 52"	\$124.00	\$120.00	\$117.00
	18" x 48" x 62"	128.00	123.00	120.00
	18" x 48" x 72"	147.00	143.00	140.00
	24" x 48" x 52"	131.00	128.00	124.00
	24" x 48" x 62"	134.00	131.00	128.00
	24" x 48" x 72"	155.00	152.00	149.00
	24" x 60" x 52"	138.00	135.00	132.00
	24" x 60" x 62"	141.00	138.00	135.00
	24" x 60" x 72"	166.00	163.00	160.00
	<ul style="list-style-type: none"> • If ordering top, back and sides using 13 ounce vinyl, and not 420 Denier nylon, add 15% to above pricing. • If ordering top, back and sides using #20 staphcheck, and not 420 Denier nylon, add 20% to above pricing. • Please remember to specify color for top, back and sides. 			
#20 StaphCheck: Wipes Clean White, Mint Green, Forest Green, Powder Blue, Navy Blue, Tan, Mauve	18" x 48" x 52"	98.00	94.00	90.00
	18" x 48" x 62"	103.00	100.00	97.00
	18" x 48" x 72"	112.00	110.00	105.00
	24" x 48" x 52"	105.00	100.00	96.00
	24" x 48" x 62"	109.00	105.00	100.00
	24" x 48" x 72"	119.00	115.00	111.00
	24" x 60" x 52"	110.00	106.00	101.00
#10 Gauge Vinyl, Clear: Wipes Clean.	18" x 48" x 52"	87.00	84.00	80.00
	18" x 48" x 62"	92.00	89.00	86.00
	18" x 48" x 72"	95.00	91.00	87.00
	24" x 48" x 52"	90.00	87.00	82.00
	24" x 48" x 62"	95.00	92.00	89.00
	24" x 48" x 72"	103.00	100.00	97.00
	24" x 60" x 52"	95.00	92.00	89.00
	24" x 60" x 62"	103.00	99.00	95.00
	24" x 60" x 72"	113.00	109.00	106.00

CUSTOMIZED EXTRAS

- Hand Holes \$8.00 each
- Top Flap Add 25% to cost
- Extra Zippers \$10.00 each
- Clear Vinyl Front Flap Add 25% to cost
- 9" x 12" Clear Vinyl Pocket \$8.00 each
- Tie Tapes \$2.50 each
- Side Flaps Add 25% to cost
- Linen Pocket Add 25% to cost
- Clear Vinyl Window \$12.00 each
- Color Coded Stripes \$10.00 each
- Urethane Coated 200D & 420D Add 20% to cost
- Stenciling (Min. 12 Covers) \$10.00 each plus cost of stencil

NOTE: Proper care should be taken to ensure that you provide us with the correct measurements, style, material, color, and details. **NO RETURNS ARE ALLOWED, unless it is determined to be a manufacturer's defect.**

*** If ONLY ONE CART COVER IS ORDERED, PLEASE ADD \$15.00 HANDLING CHARGE TO PRICE SHOWN.**

2 Mil Disposable Cart Covers No need to wash or wipe like fabric covers. Packed 50 per carton in a box or 50 per perforated roll.			
Item No.	Size (W x L x H)	Price per Case	Price per Roll
LPC-CC-500	26" x 38" x 48"	\$195.00	\$135.00
LPC-CC-501	27" x 45" x 48"	\$210.00	\$150.00
LPC-CC-502	27" x 55" x 62"	\$250.00	\$225.00
LPC-CC-503	27" x 64" x 75"	\$295.00	\$245.00
LPC-CC-504	27" x 45" x 59"	\$245.00	\$220.00

Buy 10 or more cases or rolls, take an additional 5% off above pricing. We also offer 1 mil and 1 1/2 mil disposable clear cart covers on rolls – call for pricing.

FIVE EASY WAYS TO ORDER:

1. By Mail: P.O. Box 190 • Syosset, NY 11791
2. Toll-Free: 1-800-288-3547
3. By Fax: 1-516-367-4714
4. By email: LPCORP@aol.com
5. Through our website: www.LatestProducts.net



SINCE 1972, DISTRIBUTORS OF SPECIALTY ITEMS FOR HOSPITALS, NURSING HOMES, INSTITUTIONS

LATEST PRODUCTS CORP.

P.O. Box 190 • Syosset, New York 11791 • 1-800-288-3547 • Fax 1-516-367-4714 • email LPCORP@aol.com

HAMPERSTANDS—CHROME AND STAINLESS



2010 SQUARE WITH LID & FOOT PEDAL AND BAG LOCKING RING
 18½" W x 19½" deep x 38" H
 Requires easy assembly.
 3" locking casters.
Open design for easy unloading and minimal lifting.



Now available in stainless steel.

ROUND 33330-2018
 18" Dia. x 35" H
 Holds 18" bags.
 2" casters.

ROUND 33340-2025
 25" Dia. x 36" H
 Holds 25" bags.
 3" casters.
Durable chrome plated steel.



Now available in stainless steel.

TILT-TOP ROUND 33334-2118 20" Dia. x 36" H
 Holds 18" bags.
Foot Pedal Operated Lid with 2" casters.
Recommended for infection control.
 Durable chrome plated steel lid & frame. Spring loaded lid.
Also available with top red lid.



34000 BAG HOLDER KIT



FOLDING ADJUSTABLE 33395-5061
 Holds 18-22" or 25" bags.
 3" casters.
 This model also available with lid, see below—
 model #33395-5061/6061 or with foot pedals—see model #5055, page 14.

These Hamperstands are for use with 18" and 25" Fabric Laundry Bags. (On #33340, please make sure you use 25" Dia. bags – flat measure 40" x 40".) For use with polybags we recommend our Plastic Bag Holder #34000.



TRIANGULAR SPACE-SAVER HAMPER, 18" D

Model 2301SS Triangular Space-Saver Hamper offers hands-free loading and unloading with a convenient non-slip pedal. All stainless steel construction. Bumper guards on stainless steel lid and legs protect equipment and walls. Solid shelf on bottom provides extra security with heavy loads. This hamper travels effortlessly on three, 3" hard rubber swivel casters. 18" D x 32" H.
For non-stainless steel—see pricing below—model #2302NONSS.

Number	Description	1	2	3-5	6 or more
2010	Square - Foot Pedal-Lid	\$155.00	\$150.00	\$145.00	\$135.00
33330-2018	18" Round (chrome)	125.00	120.00	115.00	110.00
33340-2025	25" Round (chrome)	145.00	140.00	135.00	130.00
33395-5061	Folding Adjustable 18-22-25" Bags	125.00	120.00	115.00	110.00
33395-5061/6061	Folding Adjustable 18-22-25" Bags with Lid	155.00	150.00	145.00	140.00
33334-2118	Tilt Top 18" Foot Pedal Opens Lid (chrome lid standard)	210.00	205.00	200.00	190.00
34000	Bag Holder Kit for 18" Round	65.00	62.00	60.00	58.00
2301SS	Triangular Space-Saver Hamper 18" Stainless	415.00	405.00	395.00	385.00
2302NONSS	Triangular Space-Saver Hamper 18" Non Stainless	205.00	200.00	195.00	190.00
33330SS	18" Stainless Steel	290.00	285.00	280.00	275.00
33340SS	25" Stainless Steel	310.00	305.00	300.00	295.00
33334SS	Tilt Top 18" Stainless Steel	455.00	450.00	445.00	440.00

More hamperstands shown on following pages.

POLYETHYLENE HAMPERSTAND WITH LID

This laundry Hamper-Host holds soiled linens, diapers, sheets, towels, gowns and other goods inside. It opens with an optional foot pedal for hands-free, no-contact access and its lid snaps shut. Any odors are sealed inside to prevent their escape into the air.



Hamper-Host shown open.



Hamper-Host shown closed.

The Hamper-Host stand is available in two sizes that fit either 18" or 25" laundry bags and your choice of 17 colors. The Hamper-Host stand is top-loading, with an integral lid so that bag and contents are completely enclosed for maximum protection and to meet Joint Commission infection control guidelines. The spring controlled lid closes gently to avoid airborne contamination. A front door allows no-lift removal of the full bag. Once the bag is filled, the outer shell is rotated to open the door. The Hamper-Host stand can be easily cleaned and sanitized with hot water. Units are shipped fully assembled. Two 3" wheels facilitate pushing or pulling. Lid opens and closes easily by hand or by using a foot pedal (priced below). The Hamper-Host is manufactured of 100% polyethylene.

17 colors available: Red, Brite Yellow, Brilliant Orange, Jade Green, Honey Gold, Powder Blue, Metallic Silver, Pink, Wine, Cadet Blue, Royal Blue, Purple, Beige, Brown, Black, Lime Green, Forest Green

Hamper-Host Model Number	Dimensions	Laundry Bag Size	Max. Capacity	1	2-3	4-5	6 or more
03H18	18" Diameter x 30½" deep x 34" overall height	18"	26¼ gallons	\$340	\$330	\$320	\$315
04H25	22½" Diameter x 30½" deep x 34" overall height	25"	45 gallons	370	360	350	345

Since Hamper-Hosts are molded to your specific color selection and are not returnable, it is very important that you determine which size you need. #03H18 holds an 18" diameter linen bag (30" x 40" flat measure) or holds a 44 gallon polybag. #04H25 holds a 25" diameter linen bag (40" x 40" flat measure) or a 55 gallon polybag.

POLYETHYLENE HAMPERSTAND WITH FOOT PEDAL

- Foot pedal as an added convenience.
- No need to touch lid for opening.
- Sizes, colors and features as shown above.

F03H18 (for 18" bag)				F04H25 (for 25" bag)			
1	2-3	4-5	6 or more	1	2-3	4-5	6 or more
\$450	\$440	\$430	\$425	\$460	\$450	\$445	\$440



STAINLESS STEEL MRI-ROOM HAMPERSTANDS

MRI-Room hamperstands are designed to be safely used near MRI equipment. These hamperstands have a round tubular ring that is seamlessly welded to three legs. A solid, round platform on the bottom acts as a bracing and protects the hamper bag from contact with the floor. A reinforced, dome-shaped lid of high-density, white polyethylene (model 7772MR-PL) is recommended to control airborne pathogens. All hamperstands move easily over floors on 2" MRI-safe swivel casters. Uses 18" laundry bags.

Model Number	Shipping Weight (lbs.)	Lid	Dimensions (overall)	1	2-3	4-5	6 or more
7772MR	20	None	20" Diameter x 35" Height	\$490	\$480	\$460	\$450
7772MR-PL	40	Plastic	22" Diameter x 36½" Height	690	680	660	650

For our full line of laundry bags see pages 3, 4, 5, 6.

We carry a complete line of MRI-Room products, please contact us for details.



SINCE 1972, DISTRIBUTORS OF SPECIALTY ITEMS FOR HOSPITALS, NURSING HOMES, INSTITUTIONS

LATEST PRODUCTS CORP.

P.O. Box 190 • Syosset, New York 11791 • 1-800-288-3547 • Fax 1-516-367-4714 • email LPCORP@aol.com

FOLDING ADJUSTABLE HAMPERSTANDS WITH LIDS

Outstanding Value!



Comply with OSHA and other regulations
Ideal for use with cloth and plastic bags

Must be ordered as a set

Adjusts to fit any bag size from 18" to 25". Stand is chrome plated 1" tubular steel. Cover is aquamarine color and has convenient hand grip for easy opening and closing. Stand and cover shipped in two cartons. Cover easily assembled. Folds to 6" for easy storage.

#5061 Hamperstand } please order
#6061 Cover } by these numbers

1	2	3-5	6 or more
\$155.00	\$150.00	\$145.00	\$140.00

Also Available with Spring Loaded Foot Pedal for Easy
"Hands-Free" Lid Opening!

Fully Assembled • Model #5055

1	2	3-5	6 or more
\$190.00	\$185.00	\$180.00	\$175.00

Easy roll 3" non-marking, silent casters.
36½" H, 17¼" W,
17½" D, 21 lbs.

DELUXE TUBULAR STEEL HAMPERS

Comes with Standard White Lid



684 Double Leakproof Hamper with Foot Pedal
37½" L x 17¾" W x 37½" H. Includes 2 bags

To Ease Workload

- Leakproof system includes removable and washable vinyl bags
- Heavy 7/8" steel tubing with chrome finish
- Lids are high impact, hands-free design
- Foot pedal for easy opening
- 4" casters (2 swivel/2 locking brake)
- Replacement bags available

Specify bag colors: Available in White, Green, Pink, Blue.

Bags are ultrasonically welded with reinforced seams for long life. Additional bags available.

Additional replacement bag #680 – 30" x 35" flat size. \$40.00 per bag. Specify color when ordering.

Double hamper includes two bags. Triple hamper includes three bags.

Flame Retardant Bags



686 Triple Leakproof Hamper with Foot Pedal
55½" L x 17¾" W x 37½" H. Includes 3 bags

Hampers with Bags		1	2-5	6 or more
Model 684	Double Hamper with two bags	\$270.00	\$265.00	\$260.00
Model 686	Triple Hamper with three bags	\$385.00	\$380.00	\$375.00

Please specify bag color when ordering.

Hampers with No Bags		1	2-5	6 or more
Model 684NB	Double Hamper—no bags	\$235.00	\$230.00	\$225.00
Model 686NB	Triple Hamper—no bags	\$340.00	\$335.00	\$330.00

Hampers if returned are subject to a 25% restocking fee plus freight charges.

Please verify colors, sizes and options carefully when ordering.

POLYETHYLENE MOBILE CART

Ideal for Contaminated Linen

A rugged, virtually unbreakable mobile cart that's just the right size for easy handling in dozens of uses.

- Dozens of uses including industrial, commercial, restaurants, hotels, hospitals, retirement homes.
- Constructed of polyethylene, molded container with attached poly cover.
- Easy to remove from rustproof, galvanized steel dolly for cleaning.

We can put 2 or 3 or 4 units on a common base.



Big Tiger

Complete with four 2" diameter casters. **Inside dimensions:** Length 18" x 16 1/2" wide x 32" deep. **Outside dimensions:** Length 22" x 19 1/2" wide x 36" high overall including dolly. **Approximate weight:** 22 1/2 lbs. Holds approximately 4 3/4 bushels or 300 lbs of liquid or 36 gallons.

Lil' Tiger

Complete with four 2" diameter casters. **Inside dimensions:** Length 18" x 10" wide x 32" deep. **Outside dimensions:** Length 22" x 13 1/4" wide x 36" high overall including dolly. **Approximate weight:** 17 lbs. Holds approximately 2 2/3 bushels or 150 lbs of liquid or 18 gallons.

Big Tiger

638 DBC with attached polyethylene cover
638 DB without cover

	1	2-3	4 or more
# 638 DBC with attached polyethylene cover	\$235.00	\$225.00	\$220.00
# 638 DB without cover	175.00	165.00	160.00

Lil' Tiger

633 DBC with attached polyethylene cover
633 DB without cover

# 633 DBC with attached polyethylene cover	\$195.00	\$185.00	\$180.00
# 633 DB without cover	145.00	135.00	130.00

For 3" diameter casters (add 1" to height) — add \$10.00 per cart.



POLYETHYLENE MULTI-PURPOSE CART WITH HINGED LID

Use for Infectious Waste or Linen

100% Galvanized Rust-Proof Steel Base and 3 1/2" Casters

See below for colors.

CASTER ARRANGEMENTS:

- A – Swivel on four corners
B -- Two rigid and two swivel on each end.

Colors: Black, White, Red, Powder Blue, Royal Blue, Burgundy, Orange, Beige, Forest Green, Yellow, Metallic Silver (Gray).

Lid available in White only.



# 139-12 (.190 wall thickness)	12 bushel 36"L x 24"W x 28"D	\$365.00
# 139-14 (.190 wall thickness)	14 bushel 39"L x 27"W x 28"D	385.00
# 139-16 (.190 wall thickness)	16 bushel 39"L x 27"W x 31"D	400.00

PUSH N' PULL HANDLE



Model # PP03 \$149.00

- A great back saver
- Eliminates bending
- Less effort to push
- Easy to install
- Easy to clean
- Fits most poly trucks and vinyl or canvas trucks. Please specify when ordering.

TERMS: 2% ten days, net 30, F.O.B. Factory. We prepay shipping and add to invoice.



SINCE 1972, DISTRIBUTORS OF SPECIALTY ITEMS FOR HOSPITALS, NURSING HOMES, INSTITUTIONS

LATEST PRODUCTS CORP.

P.O. Box 190 • Syosset, New York 11791 • 1-800-288-3547 • Fax 1-516-367-4714 • email LPCORP@aol.com

DELUXE HEAVY DUTY TUBULAR STEEL HAMPERS

Recommended to be Used With Disposable
33-40 Gallon Polybags.



Now with convenient bag locking device to hold polybags in place

Outer replacement bag #670 available

#672 shown with bag opening at front with velcro attachment.

672 "EASY ACCESS" HAMPER W/FOOT PEDAL

"Easy Access" Bags are constructed of **Sure-Chek™**, one of the best antibacterial fabrics approved for institutional use. Fabric has **antibacterial** and **flame retardant** properties built in. All deluxe hampers are constructed from 7/8" tubular steel with a sturdy chrome finish. All units ship knocked-down.

All hampers come with 4" casters and 2 swivel/2 locking brake casters.

Laundry bag, which comes with hamper, holds linen, laundry or disposable polybag and opens from front with velcro attachment.

Additional or replacement bag available: #670 \$55 each
18" L x 13½" W x 25" D



674 "Easy Access" Hamper w/ Foot Pedal —Double Hamper

Standard white lid



676 "Easy Access" Hamper w/ Foot Pedal —Triple Hamper

COLOR HAMPER LIDS

Coordinate Wings or Hamper Contents

Colors Available

- 602 White (Standard)
- 602B Blue
- 602BR Brown
- 602N Black
- 602R Red
- 602Y Yellow

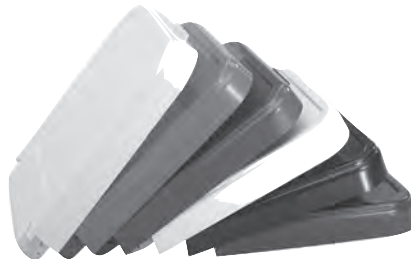

Lid size (18½" L x 17¾" W x 2½" D)

Color lids are available with an upcharge of \$5 per lid.

Item	1	2-5	6+
Single 672	\$185	\$180	\$175
Double 674	300	295	290
Triple 676	435	430	425

If no bag required, deduct \$20.00 from 672 price, \$40.00 from 674 price, and \$60.00 from 676 price.

Bulk polybag holder available which clips onto the side of the hamper. Model #661: \$20 each.

Bags available in White, Green, Pink, or Blue. Please specify when ordering.

See opposite page for Hamper Labels

Hampers if returned are subject to a 25% restocking fee plus freight charges.
Please verify colors, sizes and options carefully when ordering.

DELUXE HAMPERS WITH “LEAKPROOF” BAGS



SINGLE (18½" L x 17¾" W x 37½" H)
682 Single “Leakproof” Hamper
w/ Foot Pedal

DOUBLE (37½" L x 17¾" W x 37½" H)
684 Double “Leakproof” Hamper
w/ Foot Pedal

TRIPLE (55½" L x 17¾" W x 37½" H)
686 Triple “Leakproof” Hamper
w/ Foot Pedal



684 “Leakproof” Hamper w/ Foot Pedal



686 “Leakproof” Hamper w/ Foot Pedal

682 “LEAKPROOF” HAMPER W/FOOT PEDAL

“Leakproof” Bags are constructed of flame retardant vinyl specially formulated to be launderable. Ultrasonically welded and reinforced seams assure leakproof performance and durable long life. Bags have shock corded rim and envelope closure. All deluxe hampers are constructed from 7/8" tubular steel with a sturdy chrome finish and 4" casters (2 swivel/2 locking brake casters). All units ship knocked-down.

Additional replacement bag available: #680 \$40 each
30" x 35" flat size.

Hampers With No Bags

Item	1	2-5	6+
682NB Single Hamper—no bags	\$150	\$145	\$140
684NB Double Hamper—no bags	235	230	225
686NB Triple Hamper—no bags	340	335	330

Hampers With Bags

Item	1	2-5	6+
682	\$165	\$160	\$155
684	270	265	260
686	385	380	375

BILINGUAL HAMPER LABELS (English & Spanish)

HAMPER LABEL, SOILED LINEN

602SLB Blue Lettering, Pack of 5 \$38
602SLW White Lettering, Pack of 5 \$38

HAMPER LABEL, INFECTIOUS LINEN

602IL Red Lettering, Pack of 5 \$38

HAMPER LABEL, BIOHAZARD WASTE

602BW Black Lettering, Pack of 5 \$38

RECEPTACLE LABEL, TRASH/WASTE

602TWG Gray Lettering, Pack of 5 \$38
602TWT Tan Lettering, Pack of 5 \$38

HAMPER LABEL, RESIDENT PERSONAL LINEN

602RL Green Lettering, Pack of 5 \$38

Label size (12" x 4")

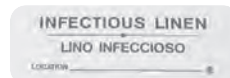
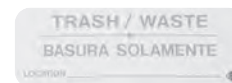
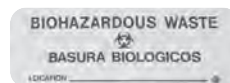

See opposite page for Color Hamper Lids

Many other Hampers and Hamperstands available.
Please see preceding pages.



SINCE 1972, DISTRIBUTORS OF SPECIALTY ITEMS FOR HOSPITALS, NURSING HOMES, INSTITUTIONS

LATEST PRODUCTS CORP.

P.O. Box 190 • Syosset, New York 11791 • 1-800-288-3547 • Fax 1-516-367-4714 • email LPCORP@aol.com

PVC SOILED LINEN HAMPERS

We will customize our PVC hampers to fit your needs. A little higher, lower, wider, narrower – it doesn't matter! Contact us for details!



C-LH-21 **\$230**
37" H x 18" L x 18" W
Price includes foot pedal.



C-JH-41 **\$260**
37" H x 22" L x 21" W
Foot pedal not included in price.
Add \$55 for foot pedal.



C-JH-42 **\$460**
37" H x 45" L x 21" W
Foot pedal not included in price.
Add \$75 for foot pedal.



C-LH-22 **\$385**
37" H x 37" L x 18" W
Price includes foot pedal.

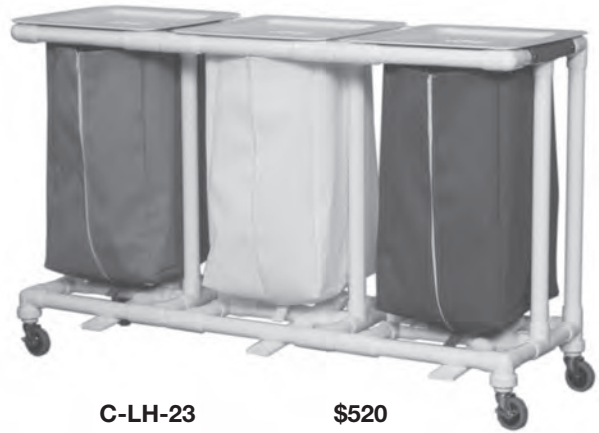

C-LH-23 **\$520**
37" H x 58" L x 18" W
Price includes foot pedal.

All Units Feature

- 3" Casters standard
- Available in Standard (LH) and Jumbo (JH) sizes
- Easy release and removal of plastic liners or bags
- Eliminates excessive bending and lifting
- Foot pedals are available on all LH and JH models
- Coated wire hangers securely hold liners or bags
- LH and JH models use standard 39 gallon plastic liners
- Includes either mesh zipper-front bag (colors: Navy, Blue, Plum, Wineberry, Maroon, Laguna, Forest Green, White, Linen or Silverado) or washable leak-proof bag (colors: Mint, Light Blue, Pink, or White).

Fully-Customizable Units Available!



- Uses disposable and reusable bags
- Can be customized to your bag, space or service conditions
- Available with or without lid
- Custom labels/stickers help identify your dirty linen hampers, department or station
- Available in MRI-compatible version
- Can be upgraded with deluxe casters

See our website for a laundry bag color chart.

PVC is the most commonly used polymer for plastic hospital products.

ECONOMY STANDS—METAL FRAMES ONLY



#23NCS or #23NCL

Small 18" L x 12" W x 32" H
#23NCS

Large 18" L x 18" W x 32" H
#23NCL

	Plain 11/32" Steel	Plated 11/32" Steel
Small #23NCS	\$30.00	\$33.00
Large #23NCL	\$32.00	\$35.00

BAG HOLDERS/CADDIES



#230 or #235

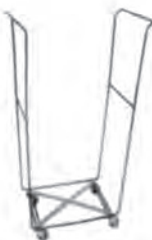

#232 or #237

Small Size Stay-Open
Bag & Net Caddy
18" Long x 12" Wide x 35" High

Large Size Stay-Open
Bag & Net Caddy
18" Long x 18" Wide x 35" High

Bag Holders	Model	Small Size Stay-Open Bag & Net Caddy		Large Size Stay-Open Bag & Net Caddy		
		Plain 11/32" Steel	Plated 11/32" Steel	Plain 11/32" Steel	Plated 11/32" Steel	
Frame only On Hardwood Runners	#230	\$33.00	\$35.00	#235	\$34.00	\$37.00
Frame w/10 oz canvas bag On Hardwood Runners	#231	\$59.00	\$62.00	#236	\$64.00	\$67.00
Frame only On 2" swivel casters*	#232	\$42.00	\$45.00	#237	\$44.00	\$47.00
Frame w/10 oz canvas bag On 2" swivel casters*	#233	\$69.00	\$73.00	#238	\$73.00	\$77.00

*Available with 3" diameter rubber swivel casters at extra price of \$10.00 per cart. Add 1" to overall height. Above prices are per unit. For orders of 5 or more units, deduct 5% from above pricing.



#231 or #236



#233 or #238

HOSPITAL SOILED LINEN CART

with attached polyethylene cover



2-3-4 units on common base connected with coupling bars. Each bar \$10.00.

SMALL SIZE 18" long x 12" wide x 35" high overall

#232LC Frame only on 2" rubber swivel casters
#233LC Frame and 10 oz. canvas bag complete on 2" rubber swivel casters

LARGE SIZE 18" long x 18" wide x 35" high overall

#237LC Frame only on 2" rubber swivel casters
#238LC Frame and 10 oz. canvas bag complete on 2" rubber swivel casters

	1-2	3-5	6 or more
#232LC	\$100.00	\$ 95.00	\$ 90.00
#233LC	130.00	125.00	120.00
#237LC	110.00	105.00	100.00
#238LC	140.00	135.00	130.00

For 3" diameter casters add \$10.00 per cart.



SINCE 1972, DISTRIBUTORS OF SPECIALTY ITEMS FOR HOSPITALS, NURSING HOMES, INSTITUTIONS

LATEST PRODUCTS CORP.

P.O. Box 190 • Syosset, New York 11791 • 1-800-288-3547 • Fax 1-516-367-4714 • email LPCORP@aol.com



DOUBLE HAMPERSTAND WITH FOOT PEDAL



Chrome Double Hamperstand

- Bag locks secure liners in place
- Six 3" easy-rolling casters
- Two casters are lockable
- Dual foot pedal operation
- Accepts poly liners or fabric bags
- ABS white plastic lids standard
- Optional colored lids available, add \$5. See page 16 for colors
- 39" L X 17" W X 35" H

Model #LPC-694R
Shown with optional colored lid.

1	2 - 5	6 or more
\$190.00	\$185.00	\$180.00

POLYETHYLENE LAUNDRY HAMPER WITH HINGED LID



- 3 bushel size or 4.5 bushel size
- .225 thick polyethylene
- Four 2" easy-roll casters
- 100% leak-proof and easy to clean
- Easy to open lid keeps laundry contained in controlled sanitary conditions

Model #LPC-639
3 bushel 19½" W x 17½" D x 31" H
4.5 bushel 19½" W x 24" D x 31" H

1	2 - 5	6 or more
\$180.00	\$170.00	\$163.00
\$205.00	\$195.00	\$185.00

Colors available: White, Blue, Gray, Red, Green, Yellow, Black, Orange, Terra Cotta, Sandstone

Latest Products is now on Facebook and Twitter.

STAPHCHECK INSTITUTIONAL PILLOWS

Vinyl Covered Pillows at Unbelievable Prices

**Resistant to Fluid – Bacteria – Fire – Static –
Hypoallergenic – Wipe Clean – Tear Resistant**

- Color White standard, also available in Blue at same price.
- No Quantity Limit. Order as many as you'd like at \$4.35 each for larger size.
- No Quantity Limit. Order as many as you'd like at \$4.10 each for smaller size.
- Save up to 80% of cost of ordinary disposable pillows.
- No laundering or pillow protectors needed.
- Anti-microbial and flame/stain/tear resistant.
- Wipe clean, fluid resistant.
- Hypoallergenic manufactured with prime polyester filling.
- Minimum order – 2 cartons.
- Packed 16 per carton (no broken cartons) for CV27/SDGK20.
- Packed 20 per carton (no broken cartons) for CV18/SDGK18.
- Freight additional.



Prime Polyester Fill

Packed	Item #	Size	Price
Pack 16/ctn.	CV27/SDGK 20	21" x 27"	\$4.35 each (\$69.60/CTN)
Pack 20/ctn.	CV18/SDGK 18	18" x 25"	4.10 each (\$82.00/CTN)

Please specify White or Blue.
CV27/SDGK 20 contains 20 ounce prime polyester fill.
CV18/SDGK 18 contains 18 ounce prime polyester fill.

BARRIER FABRIC WASHABLE INSTITUTIONAL PILLOWS

- Flame Resistant
- Noiseless
- Anti-Microbial
- Stainless and Odorless
- 100% Polyester Fill
- Available in White or Blue

Packed	Item #	Size	Price
20/ctn.	1825KARE	18" x 25"	\$4.10 each (\$82.00/CTN)
16/ctn.	2127KARE	21" x 27"	\$4.30 each (\$68.80/CTN)

ACA Striped Pillows available. Refer to our website.

Low Priced, High Quality Disposable Single-Use Pillows

- Flame Resistant
- Hypoallergenic
- Economical
- Not Washable
- 100% polyester fill
- Ticking: White polypropylene, non-woven

Packed	Item #	Size	Fill Weight	Price/Carton
20/ctn.	1825DISPLW	18" x 25"	18 ounce	\$56.00/Carton
20/ctn.	2127DISPLW	21" x 27"	20 ounce	62.00/Carton

Packaged 20 pillows per carton only.

**Refer to page 8 for Vinyl Pillow Protectors—protects against bed bugs.
Samples of pillows available upon request.**



SINCE 1972, DISTRIBUTORS OF SPECIALTY ITEMS FOR HOSPITALS, NURSING HOMES, INSTITUTIONS

LATEST PRODUCTS CORP.

P.O. Box 190 • Syosset, New York 11791 • 1-800-288-3547 • Fax 1-516-367-4714 • email LPCORP@aol.com

Custom Embroidered Heat-Sealable Emblem Patches

Use on uniform sleeves or pockets to identify institution, department or name. Available in sizes from 2" to 16". Colorfast threads, borders are merrowed (spun thread) or stitched and laser cut. Up to 7 thread colors available. Available with standard plastic backing for sewing or heat sealable adhesive backing.



To obtain immediate pricing, please call, mail, email or fax us:

1. Sketch indicating size and text copy
2. Color or colors
3. Quantity
4. Border (merrowed or stitched and laser cut)
5. Backing (standard plastic or heat sealable adhesive)

Used by hospitals, nursing homes and institutions nationwide.

Alternative to Costly Marking Systems!

Inexpensively Mark Residents' Personal Clothing,
Doctors' Coats, Lab Coats, etc.

ELIMINATE REPETITIVE PEN MARKING BY HAND!

Use this system by itself or in conjunction with heat seal machines (pages 24 and 25) and heat seal label tape (page 23).

Each kit consists of:

- One 14-band, wheel-operated Rubber Stamp enabling you to print any name up to 14 letters per name (each band has 26 letters—numbers also available upon request)
- One two ounce bottle of indelible laundry marking ink
- One stamp pad

\$199⁰⁰



Example: JOHN SMITH

Turn the first band to "J", the second band to "O", third band to "H", the fourth band to "N" and so on.

Fluid Protective Heat-Sealable Patching Material

(Must be applied with heat-sealing machines.)

Fluid Protective Medical Barrier

**Designed for Garments Made of Resistat, Compel and Blockade Fabrics.
Extend the Life of Laundry Bags and Linens, Labcoats and Surgical Gowns.**

Laundry Directors and Administrators will appreciate that at long last there is no need to discard or replace costly laundry bags, linens, labcoats, or surgical gowns. By using Maxima Patches, available in pre-cut sizes or on rolls, you can repair tears and imperfections and extend the life of your garments/laundry and linen. Maxima, our fluid protective medical barrier fabric is 100% polyester, OSHA mandated and approved medical barrier to protect against body fluids and blood borne pathogens.

PRODUCT #	PATCH SIZE	PACKED PER BOX	PRICE PER BOX
FPB-1	7/8" x 1"	1000/box	\$36.00/box
FPB-2	7/8" x 1 1/2"	1000/box	\$55.00/box
FPB-3	7/8" x 2"	1000/box	\$72.00/box

PRODUCT #	ROLL SIZE	PRICE PER ROLL
FPBR-1	3/4" x 50 yards	\$36.00/roll
FPBR-2	1" x 50 yards	\$44.00/roll
FPBR-3	1 1/4" x 50 yards	\$54.00/roll

Standard colors: Misty Green, Brushed Eyres Green, Ceil Blue, Yellow, Brushed Light Blue or Green. For Blue Compel garments, please specify Cloud Blue. For Blockade, specify Yellow, Misty Green or Ceil Blue. For Resistat garments, specify Brushed Light Blue or Brushed Green.

Other sizes and shapes available.

Please note—**Minimum patch billing \$75.00**

Application Procedure: Apply at 380 degrees for 10 seconds using a heat-sealing machine.

Call for testing samples.

FIVE EASY WAYS TO ORDER:

1. **By Mail:** P.O. Box 190 • Syosset, NY 11791

2. **Toll-Free:** 1-800-288-3547

3. **By Fax:** 1-516-367-4714

4. **By email:** LPCORP@aol.com

5. **Through our website:** www.LatestProducts.net

HEAT-SEALABLE PATCHING MATERIAL

(Must be applied with heat-sealing machines.)

Use Your Heat-Sealable Mending Patches and Heat Sealing Machines and You Will Prolong the Life of Bed Linen, Surgical Linen, Coats and Uniforms.

Colors: Most popular are White, Jade Green, Misty Green, Kilarny Green, Ceil Blue, and Yellow. Also available are Powder Blue, Medium Blue, Postman Blue, Lilac, Black, Burgundy, Teal, Brown, Gray, Charcoal, Navy, Orange, Pink, Red, Spruce Green, Tan. In Twill we have Brown, Gray, Navy, White, Black, Charcoal, Royal Blue, Ceil Blue, Red, Spruce, and Denim.

Many other colors and twills now available.

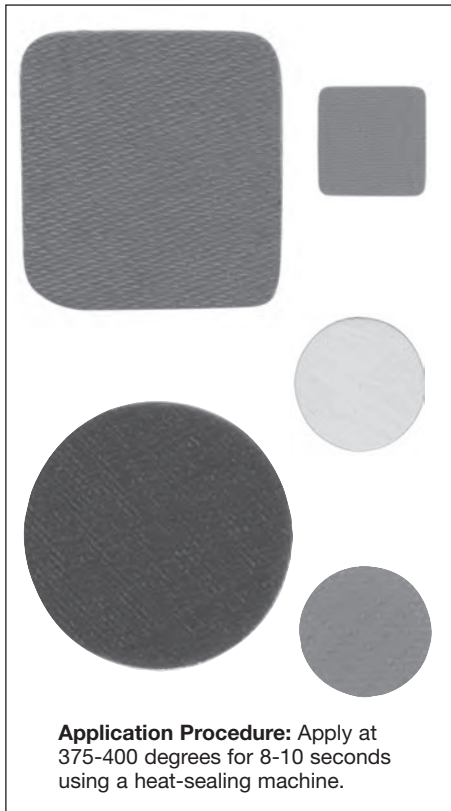

Application Procedure: Apply at 375-400 degrees for 8-10 seconds using a heat-sealing machine.

LPC MEND PRE-CUT PATCHES				LPC MEND ROLL PATCHING MATERIAL		
NUMBER OF PIECES PER BOX	SQUARE & RECTANGULAR PRE-CUT		Price Per 1000	ROLL		
	Code	Size		Code	Size	Price Per Roll
4M	A	1/2" x 1/2"	\$ 11.00	N	1" x 50 Yards	\$20.75
2M	B	3/4" x 3/4"	11.90	O	1 1/4" x 50 Yards	23.50
2M	C	1/2" x 1"	13.50	P	1 1/2" x 50 Yards	30.00
2M	D	1" x 1"	16.75	Q	2" x 50 Yards	39.00
1M	E	3/4" x 2"	21.75	R	3" x 50 Yards	60.00
1M	F	3/4" x 3"	32.50	S	4" x 50 Yards	79.00
1M	G	1 1/2" x 1 1/2"	28.50	Other Sizes Available		
500	H	2" x 2"	49.50	LPC SEALABLE LABEL TAPE		
250	I	3" x 3"	95.00	FOR PRINTING		
250	J	4" x 4"	190.00	NAMES		
1M	K	1" x 3"	40.50	5/8" x 50 Yards	\$17.00	
1M	L	1" x 5 1/2"	85.00	3/4" x 50 Yards	18.50	
Other Sizes Available				1" x 50 Yards	20.75	
ROUND PRE-CUT PATCHES				1 1/4" x 50 Yards	23.50	
2M	BR	3/4"	\$ 11.75	1 1/2" x 50 Yards	30.00	
2M	DR	1"	17.00	Other Sizes Available		
1M	GR	1 1/2"	29.00	♦♦♦ MINIMUM BILLING \$75.00 ♦♦♦		
500	HR	2"	50.50			
250	IR	3"	99.00			

Call or fax us for free testing samples.

Heat-seal machines on pages 24 and 25. Heat Dye Transfers featured on page 26.

COMPUTER HEAT-SEALABLE LABEL TAPE

Polycotton or 100% Polyester

Heat-sealable color-coded label tapes provide for an inexpensive marking and tracking system. Patient names, departments, floors, etc. can be identified. For use with form feed printers only. Colors available are white, red, blue, tan, kelly green, orange, pink, lavender, and yellow. One thousand labels per roll. Must be adhered with heat-sealing machines. Polyester material ideal for identifying undergarments.

LABEL SIZE	CATALOG NUMBER	PRICE PER THOUSAND POLYCOTTON	PRICE PER THOUSAND POLYESTER
1" x 3-1/4"	#TD-1325	\$61.00/Roll	\$74.00/Roll
5/8" x 3-1/4"	#TD-58325	46.00/Roll	58.00/Roll
5/8" x 2-1/2"	#TD-58250	45.00/Roll	57.00/Roll
2/3" x 3-1/4"	#TD-23325	46.00/Roll	58.00/Roll
1/2" x 2-1/2"	#TD-50250	45.00/Roll	57.00/Roll

Samples of patching material available upon request.



HEAT SEALING MACHINES

Introducing a full line of heat seal machines.

The DK8 label press is a 6x8 small platen heat press.

It is a heavy duty clamshell design, for label printing and small transfer and applique sealing. If your image area is less than 8 inches and you need to isolate an area of garment or bag, the tall pedestal on the DK8 allows for precise location. Pockets, collars, socks, sleeves and similar areas are easy to press without flattening parts of the garment that should not be pressed. The included interchangeable tables allow for isolation of the pressing area down to 3x3 inches.

Features:

- Fully digital temperature control: 32° - 600°F range
- Automatic digital timer and dual pre-press timer
- 70 programmable presets
- Hardened high-strength pivot points
- Solid steel framework
- 6x8, 3x5, 3x3 interchangeable tables included
- Temperature readout accuracy +/- 2° F; can show °C or °F
- Self lifting gas-spring, and wide opening
- User selectable end-of-cycle alarms
- Records number of pressing cycles done
- Teflon-coated 3/4" thick heat platen
- Lifetime warranty on heat platen
- 3-year warranty on control
- 1-year warranty on entire press

Weight: 65 Lbs.
Electrical: 600W / 5A / 110V
Dimensions: 19"L x 12"W x 18"H



DK8 6x8 Label Press Clamshell

Price: \$650.00

DC8 Heavy Duty Swing Away Heat Press

This unit has a swing away top to allow for easy placement of garments on bottom platen. Suited for label printing, applying labels to garments, embroidered patches and all small pressing needs.

Features:

- Fully digital temperature control: 32° - 600°F range
- Automatic digital timer and dual pre-press timer
- Digital pressure bar graph
- Interchangeable heat platens and tables
- Solid steel welded framework
- Super Coil-Microwinding™ heater technology
- Temperature readout accuracy +/- 2° F; can show °C or °F
- Accomodates materials up to 1" thick
- 70 programmable presets
- Records number of pressing cycles done
- Teflon-coated 3/4" thick heat platen
- Lifetime warranty on heat platen
- 3-year warranty on control
- 1-year warranty on entire press

Weight: 110 Lbs.
Electrical: 1500W / 12A / 120V
Dimensions: 23"L x 23"W x 23"H

Price: \$1,195.00
(add \$35.00 for 220V international)

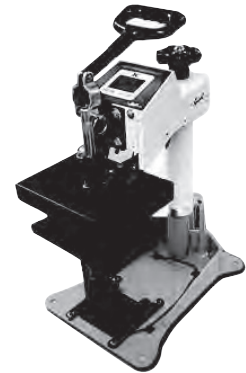

DC8 Manual Swing-Away

The DC8AP is an air operated automatic swing-away heat press.

The DC8AP is an air operated, automatic 6x8 label sized swing-away heat press with optional interchangeable heat platens and tables. The smooth automatic pressing and push button activation provide a productive fatigue-free operation. Ideally suited for label printing, applying labels to garments, embroidered patches and any small pressing needs.

Also available are optional configurations for the DC8AP. This press functions well with bottom heat for pressing thicker embroidered patches/appliques and other products needing heat from the back side of the material.

Features:

- Total applied force of 800 lbs. maximum
- Air regulator and gauge 20-100 psi range (compressor required).
- Automatic air operated pressing
- And all other features as listed above

Price: \$2,250.00
(add \$35.00 for 220V international)

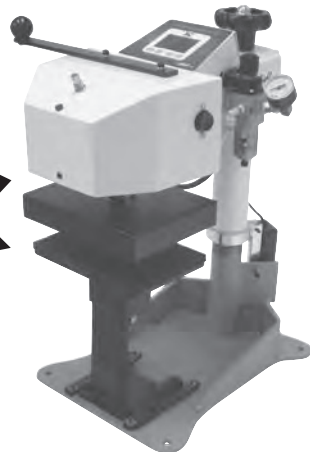

Weight: 110 Lbs.
Electrical: 600W / 5A / 120V
Dimensions: 23"L x 23"W x 23"H

DC8AP Air Operated Automatic 6'x8' Swing-Away

Many other sizes, models and accessories available - please inquire.

We support any of our discontinued machines with parts and service.

MANUAL HEAT-SEAL MACHINES

Used for applying transfers, heat sealable patches and repairing garments.



LPC #10
Manual Top Heat Seal Machine
\$525.00

- 13" x 8" x 14" overall size.
- 4" x 6" heating surface.
- Stainless steel base.
- On and off switch.
- Pilot light.
- Adjustable thermostat.
- Digital timer.
- 400 Watts.
- 4 Amp, 60 cycle, 110 Volt AC.
- Weighs only 25 lbs.

Economy line for low to moderate use.



LPC #2-HH
Manual Top and Bottom Heat Seal Machine
\$695.00

- 13" x 8" x 14" overall size.
- 4" x 6" heating surface.
- 800 Watts, 60 cycle, 110 Volt AC, 8 amp.
- Top and bottom heat with heat indicators.
- Adjustable thermostats.
- Digital timer, heat gauge.
- Pressure control is preset for all specific needs.
- Non-skid rubber feet.
- Requires no air to operate.
- Completely portable unit.
- Weighs only 26 lbs.

COMPACT HEAT-SEAL MACHINES

For moderate and frequent use.



LPC 25-HS3E
\$1,189.00

Manually open at the end of press cycle.

Featuring:

- Press head size 3.75" x 4.75"
- Digital readouts and controls
- Energy saving feature (Sleep Mode)
- Meets CE & GS Standards
- No compressed air required
- Heats up in less than 5 minutes
- Compact and lightweight
- Adjustable pressure



LPC 35-HS4E
\$1,469.00

Automatically opens at the end of press cycle.

Specifications	LPC 25-HS3E	LPC 35-HS4E
Electronic Requirements:	115 Volts	115 Volts
Electrical Consumption:	640 Watts, 6 Amps	640 Watts, 6 Amps
Temperature Range:	69-446°F (20-230°C)	69-446°F (20-230°C)
Sealing Pad Area:	3.75" x 4.75" (95 mm x 120 mm)	3.75" x 4.75" (95 mm x 120 mm)
Machine Height X Width X Depth:	19.3" x 7.5" x 20.4" (490 mm x 190 mm x 520 mm)	19.3" x 7.5" x 20.4" (490 mm x 190 mm x 520 mm)
Machine Net Weight:	55 lbs. (25 kg)	57 lbs. (26 kg)

We support any of our discontinued machines with parts and service.



SINCE 1972, DISTRIBUTORS OF SPECIALTY ITEMS FOR HOSPITALS, NURSING HOMES, INSTITUTIONS

LATEST PRODUCTS CORP.

P.O. Box 190 • Syosset, New York 11791 • 1-800-288-3547 • Fax 1-516-367-4714 • email LPCORP@aol.com

**How Directors of Laundry/Linen
Reduce Theft and Loss of Valuable Property:**

HEAT DYE TRANSFERS Kaumographs to Mark Linen and Gowns

This is the easiest, most inexpensive method of marking and identifying linen and garments. Our **HEAT DYE TRANSFERS** are easily applied with 3 to 5 seconds of heat from any heat sealing machine. Once applied, they will withstand multiple launderings and deter pilferage greatly.

We can supply you with the logo and message you want, in the shape, color and wording of your choice.

Call for free testing samples.

Pricing is per square inch of transfer. To find square inches, please multiply length and width of your design or transfer.

PRICE PER THOUSAND					
Square Inches	10,000	25,000	50,000	100,000	Initial Orders Cost of Engraving
For transfers smaller than 6 square inches, use the 6 square inch pricing.					
6	\$26.00	\$25.85	\$25.75	\$25.50	\$120.00
7	27.00	26.85	26.75	26.50	125.00
8	28.00	27.85	27.75	27.50	130.00
9	29.00	28.85	28.75	28.50	135.00
10	31.00	30.85	30.75	30.50	140.00
11	34.00	33.85	33.75	33.50	145.00
12	36.00	35.85	35.75	35.50	150.00
14	40.00	39.85	39.75	39.50	155.00
16	42.00	41.85	41.75	41.50	170.00
18	45.00	44.85	44.75	44.50	185.00
20	47.00	46.85	46.75	46.50	220.00

We can supply printed or embroidered labels, names, titles, departments, etc. Refer to page 22.

Engraving plates are kept for 2 years. If transfers are not reordered within 2 years, a new engraving charge may apply.

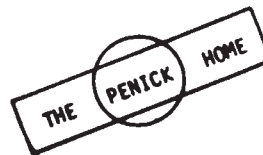
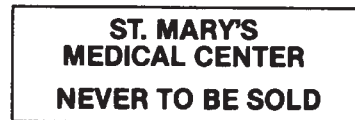

We can make transfers up to 7 1/2" x 7 1/2"

For sizes of two to five square inches, use prices of six inch column.

COLORS: black, blue, green, red, white and others. Note: black will be supplied unless otherwise requested.

For two color transfers, double the per thousand transfer cost and double the engraving cost.

Engraving cost charged on first order only.

Heat Dye Transfers are put up on continuous roll form. If sheeting (individual cut) is desired, add \$5.00 per thousand to cost of transfers.

Application of Heat Dye Transfers: 3 to 5 seconds, 350-400 degrees heat. Maximum pressure.

Samples of Heat Dye Transfers available upon request.

SEAMLESS ONE PIECE MOLDED POLYMER TRUCKS

See Following Pages for
Prices and Specifications

WASHROOM
TRUCKS
47P Series



FLARE
TRUCKS
24P24



UTILITY
TRUCKS
50P Series



SECURITY TRUCK
#74P/PSL6
(with door & lid)



LINEN TRUCK
#640001S



90 PSL Series
95 PSL Series



ROUNDTRIPPER
WITH SHELVES
87P Series
88P Series
90P-91P-92P Series
95P Series



BULK DELIVERY
TRUCKS
70P Series

Specifications and Prices Follow



SINCE 1972, DISTRIBUTORS OF SPECIALTY ITEMS FOR HOSPITALS, NURSING HOMES, INSTITUTIONS

LATEST PRODUCTS CORP.

P.O. Box 190 • Syosset, New York 11791 • 1-800-288-3547 • Fax 1-516-367-4714 • email LPCORP@aol.com

POLYMER BULK AND CONVERTIBLE TRUCKS

Latest Products Has the Finest and Most Complete
Line Of Molded Trucks Available

Specifications and Prices on Following Pages



No. 72P Bulk Truck
(without door & lid)



No. 70P
Bulk Truck



No. 64P Bulk Truck



No. 90P
Roundtripper
Convertible
Shelf Truck



No. 87P Roundtripper
Convertible
Shelf Truck



No. 74P/PSL6 Security Truck
(with door & lid)

OPTIONS/ACCESSORIES

We offer a complete line of accessories
and options for all our carts.

- 3/4" drain valves
- Cart covers – see pages 10-11
- Wide variety of tow hitches
- Wheel brakes
- Card holders
- Swivel locks
- Larger industrial casters
- Polyurethane casters
- Hinged lids
- Plastic bases
- Cart liners/caps
- Spring platforms

PUSH N' PULL HANDLE



Model # PP03 \$149.00

- A great back saver
- Eliminates bending
- Less effort to push
- Easy to install
- Easy to clean
- Fits most poly trucks and vinyl or canvas trucks. Please specify when ordering.

All carts and trucks subject to a 25% restocking fee plus freight charges
for returned items for any reason except manufacturer's defects.

PRICE LIST

**MATERIALS: Virgin Polymer—Choice of Colors
Recycled Polymer—No Color Choice Available**

**All recycled polymer carts are eco-friendly!
Please specify color and caster arrangements described below.**

Discounts available for 3 or more carts!

Model	Color Choice Available Virgin Polymer	No Color Choice Available Recycled Polymer	Capacity		Dimensions in Inches			Overall Height	Casters		Plastic Base Available
					Outside		Depth		Arrangement	Data	
					Cu. Ft.	Bu.					
64P Bulk Truck	\$1,050	\$ 915	60	48	60	42	41	48½	D	6-in. Rubber	
70P Bulk Truck*	580	520	36	29	48	28½	47	54½	A, B	6-in. Rubber	X
71P Bulk Truck	600	540	41	33	40	26	68	75½	A, B	6-in. Rubber	
72P Bulk Truck*	630	555	48	38	48	28½	59	66½	A, B	6-in. Rubber	X
73P Bulk Truck	650	575	42	34	41	28½	64	72	A, B	6-in. Rubber	
74P Bulk Truck*	580	520	32	26	41	28½	51	59	A, B	6-in. Rubber	
75P Bulk Truck	590	515	37	30	38	28½	60	67½	A, B	6-in. Rubber	
76P Bulk Truck	625	545	46	37	42	28½	68	76	A, B	6-in. Rubber	
77P Bulk Truck	575	495	33	27	41	30	51	59	A, B	6-in. Rubber	
78P Bulk Truck	800	720	70	56	52½	43½	56	65	A, B	6-in. Rubber	
79P Bulk Truck	800	720	61	49	53½	37	56	65	A, B	6-in. Rubber	
85P Convertible Shelf Truck	1,150	1,015	49	40	59½	27½	54	64½	A, B	8-in. Rubber	
90P Convertible Shelf Truck	830	695	38	32	48	28½	54	62	A, B	6-in. Rubber	X

*Models 70P, 72P and 74P now available with optional spring platform. Add \$99 for platforms.

Selected trucks now available with a plastic base if desired (same price). Standard base is made of powder coated steel for strength and rust resistance. Plastic base protects against corrosion or harsh chemical agents.

When ordering please specify if you want hand holes and/or drain holes.

Buy 3 or more, take an additional 5% off.

**Trucks featured on this page are supplied with drain holes unless you specify to omit.
Drain valves instead of drain holes are \$15 extra per truck.**

Colors

Pink	Purple	Lime Green
Wine	Brite Lemon	Jade Green
Red	Brilliant Orange	Forest Green
Powder Blue	Beige	Honey Gold
Cadet Blue	Chocolate Brown	Metallic Silver (Gray)
Royal Blue	Black	

CASTER ARRANGEMENTS:

- A: Swivel at four corners**
- B: Swivel at one end, fixed at other**
- C: Diamond pattern, fixed on sides, swivel at ends**
- D: Six casters—swivel at four corners, two fixed in middle**

Please verify that truck selected will fit through doors

**All carts and trucks subject to a 25% restocking fee plus freight charges
for returned items for any reason except manufacturer's defects.**



SINCE 1972, DISTRIBUTORS OF SPECIALTY ITEMS FOR HOSPITALS, NURSING HOMES, INSTITUTIONS

LATEST PRODUCTS CORP.

P.O. Box 190 • Syosset, New York 11791 • 1-800-288-3547 • Fax 1-516-367-4714 • email LPCORP@aol.com

LARGE SELECTION OF POLYMER TRUCKS IDEAL FOR

- Hospitals
- Nursing Homes
- Assisted Living Facilities

- Correctional Institutions
- Lodging/Hospitality

- Construction Industry
- Spas/Resorts

Specifications and Prices on Next Page



No. 50P-16 Utility Truck
Also available in a recycling model—
please inquire



No. 25P24 "Rising Platform" Truck



No. 24P24 Nestable Flare Truck



No. 44P Utility Truck



Molded Hamperstand
(see page 13)



No. 47P Utility Washroom Truck—
Tapered Hopper Bottom



No. 41C Elevated Truck



No. 54P Utility Truck



No. 75P Sling Container



No. 54P-40E Utility Truck
with Cut-Out



No. 27P14 Small-Piece Truck

CASTER ARRANGEMENTS

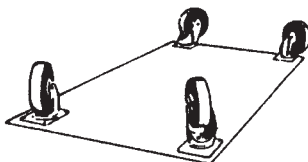

A. Swivel all four corners.

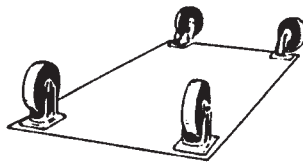

B. Swivel at one end, fixed at other end.
(Not recommended for Models
24P24 or 47P.)

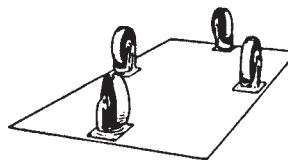

C. Diamond pattern: fixed on sides, swivel on ends.
(Not recommended for Models 24P24,
47P, 70 Series or 80 Series.)

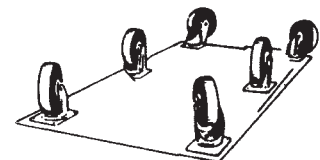

D. Four swivel corner mount
two fixed in middle.

Note: All swivel casters have double ball bearing raceways.

TERMS: 2% ten days, net 30, F.O.B. Factory. We prepay shipping and add to invoice.

PRICE LIST

MATERIALS: Virgin Polymer – Choice of Colors
Recycled Polymer – No Color Choice Available
No drain holes unless you specify.

Please specify color and caster arrangement shown below. (No color choice on recycled polymer.)

Model	Color Choice Available Virgin Polymer	No Color Choice Available Recycled Polymer	Capacity		Dimensions in Inches				Casters	
					Outside		Depth	Overall Height	Arrangement	Data
					Length	Width				
Cu. Ft.	Bu.	Length	Width	Depth	Overall Height	Arrangement	Data			
24P24 Flare Truck	\$ 500	\$460	30	25	64	40	25½	32	A, B	5-in. Rubber
25P24 Rising Plat. Truck	920	820	23.5	19	66	35	24	30½	D	5-in. Rubber
27P14 Small Piece Truck	485	433	16.5	13	56	23	25	30½	A, B	5-in. Rubber
28P18 FWI Rising Plat. Tr.	800	720	18	16	56	24	25	31	A, B	5-in. Rubber
41Cx2 Elevated Truck	***	X	2	1.75	25	17	12	29	A	3-in. Rubber
41Cx4 Elevated Truck	***	X	5.5	4.25	30	23	18	29	A	3-in. Rubber
41Cx6 Elevated Truck	***	X	7.5	6	32	23	21	29	A	3-in. Rubber
44P-12 Utility Truck	300	265	11.5	10	38	29	27	34	A, B, C	5-in. Rubber
44P-14 Utility Truck	330	305	13	11	44	31	25½	32	A, B, C	5-in. Rubber
44P-16 Utility Truck	380	345	17.5	14	49	31½	27½	34½	A, B, C	5-in. Rubber
44P-18 Utility Truck	460	415	20.5	17	54	29½	27	34	A, B, C	5-in. Rubber
47P Washroom Truck	530	475	14.5	12	48½	31	30	32	A, B	5-in. Rubber
50P-12 Utility Truck	325	300	13	11	35½	24½	28	34½	A, B, C	5-in. Rubber
50P-14 Utility Truck	385	360	19	16	39½	28½	32	38½	A, B, C	5-in. Rubber
50P-16 Utility Truck	435	405	21	18	43½	28½	32	38½	A, B, C	5-in. Rubber
50P-16 Molded Hinged Slide-on Lid	140	X	—	—	—	—	—	—	—	—
50P-16 Aluminum Hinged Slide-on Lid	300	X	—	—	—	—	—	—	—	—
54P-16 Utility Truck	415	X	18.5	15	42½	28½	28	34½	A, B, C	5-in. Rubber
54P-16 Molded Hinged Slide-on Lid	145	X	—	—	—	—	—	—	—	—
54P-16 Aluminum Hinged Slide-on Lid	300	X	—	—	—	—	—	—	—	—
54P-18 Utility Truck	525	480	22.5	18	53½	28½	27	33½	A, B, C	5-in. Rubber
54P-18 Aluminum Hinged Slide-on Lid	300	X	—	—	—	—	—	—	—	—
54P-26 Utility Truck	540	500	33	27	53½	28½	39	45	D	5-in. Rubber
54P-40 Utility Truck	680	615	40	32	76	40½	25	32	D	5-in. Rubber
54P-47 Utility Truck	1,085	900	58	47	71	46	35½	43	D	6-in. Rubber
75P Sling Container	300	275	13.5	11	31½ (dia.)		36	43	A	5-in. Rubber
100P Sling Container	315	290	15.5	12.5	34 (dia.)		35	42	A	5-in. Rubber
54P-40E Truck - cutout	685	615	40	32	76	40½	25	32	D	5-in. Rubber

***Price available upon request.

All recycled polymer carts are eco-friendly!

Colors

Pink	Purple	Lime Green
Wine	Brite Lemon	Jade Green
Red	Brilliant Orange	Forest Green
Powder Blue	Beige	Honey Gold
Cadet Blue	Chocolate Brown	Metallic Silver (Gray)
Royal Blue	Black	

CASTER ARRANGEMENTS:

- A: Swivel at four corners**
- B: Swivel at one end, fixed at other**
- C: Diamond pattern, fixed on sides, swivel at ends**
- D: Six casters—swivel at four corners, two fixed in middle**

Buy 3 or more, take an additional 5% off.

Please verify that truck selected will fit through doors



SINCE 1972, DISTRIBUTORS OF SPECIALTY ITEMS FOR HOSPITALS, NURSING HOMES, INSTITUTIONS

LATEST PRODUCTS CORP.

P.O. Box 190 • Syosset, New York 11791 • 1-800-288-3547 • Fax 1-516-367-4714 • email LPCORP@aol.com

SECURITY BULK DELIVERY/ PICK-UP TRUCK

**Ideal for
Removal of
Bagged and
Infectious Waste**

**Use for Delivery of Clean Linen or Pick-up
of Soiled/Contaminated Linen or Waste.**

**Buy 3 or
more and
deduct 5%**

Our bulk linen trucks are dependable workhorses for hospitals, nursing homes, correctional institutions, commercial laundries and companies serving these industries.

- Ergonomic cutaway design speeds loading and unloading
- Closure secures goods during transport and storage
- Rugged polyethylene construction resists bumps, scratches and scrapes
- UV-resistant, waterproof body thrives in punishing indoor/outdoor conditions
- Powder-coated, full-perimeter steel base for strength, rust resistance*
- Front door with hasp drops down for front loading
- Top lid is split for optional top loading
- When closed, lid locks with closed front door for security using your own padlock
- Easy rolling 6" rubber casters
- Drain holes can be eliminated—drain valve is available at \$15/truck. When ordering please specify if you want hand holes and/or drain holes.

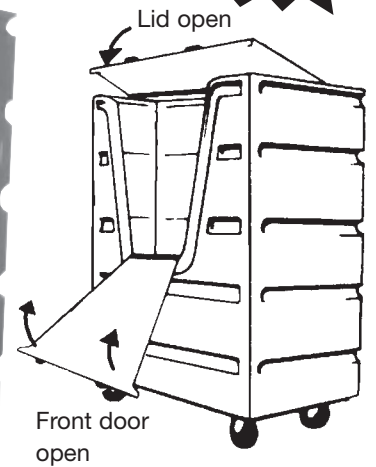

Available Body Colors

Pink	Cadet Blue	Lime Green	Brite Lemon
Wine	Brilliant Orange	Jade Green	Forest Green
Red	Beige	Royal Blue	Honey Gold
Powder Blue	Chocolate Brown	Purple	Metallic Silver (Gray)
	Black		

**Our
#1
Selling Truck**

	Item No.	Cu. Ft.	Bu.	Length	Width	Overall Depth	Height	Price	Lid Color
MOST POPULAR →	72P/PSL6*	48	38	48	28½	59	66½	\$935.00	Black
SMALLER SIZES {	70P/PSL6*	36	29	48	28½	47	54½	850.00	White
AVAILABLE	74P/PSL6	32	26	41	28½	51	59	840.00	White

*Trucks supplied with 14 gauge powder coated steel base (standard). Models 72P/PSL6 and 70P/PSL6 are now also available with a plastic base (protects against corrosion and harsh chemicals) if desired at same price. Please specify if you prefer plastic.

All above with 6" casters. For recycled polymer, (no color choice) deduct \$50.00 from above prices. Available with 8" casters which increase overall height by 2 inches. Add \$30.00 per truck.

CASTER ARRANGEMENTS

A—Swivel on four corners B—Two rigid and two swivel on each end

PLEASE SPECIFY IF YOU WANT DRAIN HOLES OMITTED

Drain valve—add \$15.00 per truck.

Delivery trucks if returned are subject to a 25% restocking fee plus freight charges incurred.

Please verify colors, sizes and options carefully when ordering.

LINEN DELIVERY TRUCKS TO DELIVER CLEAN LINEN AND PICK UP SOILED LINEN

Our 90P series bulk linen trucks feature a novel roundtrip design that enables hospitals, nursing homes, commercial laundries, and laundry service companies to use the same cart for delivering finished, folded goods and for picking up and returning soiled linens. The 90P comes with a choice of wire or plastic horizontal shelves that after delivery, one person can easily slide into a vertical position for use as a bulk laundry cart.

Choose from Traditional Wire or Plastic Shelves.

90P Roundtripper Open Top with Removable Shelves

Pricing: 90P/W Truck with 2 Wire Shelves \$925.00
90P/P Truck with 2 Plastic Shelves \$925.00

Both Models Available In Recycled Polymer \$825.00

Options: Additional Wire Shelf (2 included) Add \$100.00
Hinged 2 Wire Shelves Add \$125.00
Hinged 3 Wire Shelves Add \$135.00
Recessed Handles Add \$ 30.00
Card Holder Add \$ 30.00

When ordering, please specify wire or plastic shelves, metal or plastic base.
Please see bottom of page for available colors.



90P Plastic Shelves
Shelves positioned to collect dirty linen.
Open top



90P Wire Shelves
Shelves positioned to deliver clean linen.
Open top

ROUNDTRIPPER

Capacity		Outside			Overall Height	Casters	
Cu. Ft.	Bu.	Length	Width	Depth		Arrangement	Data
38	32	48	28½	54	62	A, B	6-in. Rubber

Please specify casters: A (4 swivel) or B (2 swivel/2 rigid).



Comes with powder coated (standard) metal base or plastic base (same price). Plastic base protects against corrosion or harsh chemical agents. UV resistant, waterproof body, thrives in indoor/outdoor conditions. When ordering please specify if you want hand holes and/or drain holes. **Correctional facilities prefer a metal-free base for safety concerns.**

LINEN DELIVERY TRUCK WITH PLASTIC TOP AND PLASTIC SHELVES

90PL Clean Linen Delivery Truck With Hard Top

Pricing: 90PL Truck with 2 Plastic Non-Removable Shelves and Key Lockable Doors \$1,400.00
90PL Truck with 2 Plastic Non-Removable Shelves and Vinyl Flap Closure \$1,100.00

Options: Recessed Handles Add \$ 30.00
Card Holder Add \$ 30.00

90PL: Dimensions are same as 90P above. 90PL has a permanent hard top.

Available with either metal base (standard) or plastic base (same price). Key lockable doors keep linens clean and dry and provide for security.



90PL with flap and no doors.
Shown with front flap in open position.



90PL shown with key lockable heavy duty doors instead of flap.

90PL Clean Linen Delivery Truck with Hard Top and with choice of molded doors or vinyl flap.

Our 90PL series is the first bulk linen delivery truck that comes with style, class and luxury appeal. It is a high-capacity, attractive clean linen delivery truck designed for hospitals, nursing homes, upscale hotels, resorts, and other properties where a premium is placed on visual appeal as well as durability and longevity. When ordering please specify if you want hand holes and/or drain holes.

Colors available for 90P and 90PL: Pink, Wine, Red, Powder Blue, Cadet Blue, Royal Blue, Purple, Brite Lemon, Brilliant Orange, Beige, Chocolate Brown, Black, Lime Green, Jade Green, Forest Green, Honey Gold, Metallic Silver (Gray)

Please specify casters: A (4 swivel) or B (2 swivel/2 rigid).

All carts and trucks subject to a 25% restocking fee plus freight charges for returned items for any reason except manufacturer's defects.



SINCE 1972, DISTRIBUTORS OF SPECIALTY ITEMS FOR HOSPITALS, NURSING HOMES, INSTITUTIONS

LATEST PRODUCTS CORP.

P.O. Box 190 • Syosset, New York 11791 • 1-800-288-3547 • Fax 1-516-367-4714 • email LPCORP@aol.com

Quantity discounts available, please inquire



Model 90PSL

BULK LINEN ROUNDTRIPPER TRUCKS WITH KEY LOCKABLE DOORS AND OPENING TOP

Provide safe transport! Discourage pilferage!
Ideal for hotels, spas, resorts, lodges and healthcare facilities.

- Two repositionable shelves slide easily from horizontal to vertical positions to convert from clean linen delivery to soiled return.
- Doors close and lock with shelves in either position.
- Recessed, molded-in handles are placed inside the swiveling end for easy, safe movement.
- Open doors swing 270 degrees and snap into sides of cart to maintain sleek profile and fit into tight spaces.
- Double-wall, molded doors with high-grade stainless steel latch and security lock safeguard goods.
- Split hinged top opens for ergonomic access to linens, seals shut and locks for over the road transport and security.
- Double wall construction withstands repeated use.
- Industrial grade 6" casters withstand constant, punishing operation.
- New all-plastic base accommodates 600 lbs. without crumpling, cracking or deteriorating. Can be used in automatic cart washers.
- Choose new plastic or rust-resistant powder-coated steel base.

*For color selection please see below.

Please specify casters: 4 swivel or 2 swivel/2 rigid.

Also available: Model 95PSL with 3 plastic shelves; 49 cubic foot capacity; 58" L x 30 3/4" W x 63 3/4" Deep x 72" Overall Height. \$1,925.00 per cart

Model 90PSL \$1,525.00 per cart					
Capacity (Cu. Ft.)	Capacity (Bu.)	Width (Outside)	Length (Outside)	Depth	Height (Overall)
38.0	32	28"	48"	54"	62"

HEAVY DUTY ROUNDTRIPPER TRUCK

The new 100P bulk linen truck features an internal rib design and steel-top ring that nearly doubles the strength, structural integrity and load bearing capacity of the cart.

- Handles overloads to 700 lbs. – even above the upper rim of the cart.
- Smart design and sturdy shelves prevents shelf collapse.

Choose non-removable wire shelves for one-way use or repositionable plastic shelves (please specify—same price) for round-trip use. Made of durable polyethylene – comes with industrial grade 6" casters. Durable body on either plastic base or powder-coated full perimeter steel base.

Please specify. Same dimensions as 90PSL (above).

*For color selection please see below.

Please specify casters: 4 swivel or 2 swivel/2 rigid.

Recessed Tow Hitch Available with Steel Base – Add \$40

Model 100P \$1,050.00 per cart



Model 100P

Two plastic shelves included; shelves shown positioned to collect dirty linen. Open top.

ECONOMY CONVERTIBLE ROUNDTRIPPER SHELF TRUCKS

Your Choice of Removable or Permanently Hinged Wire Shelves. Open Top.
Avoid Lost or Misplaced Loose Shelves by Using Permanently Hinged Shelves.

Please specify casters: A (4 swivel) or B (2 swivel/2 rigid). For color selection see below.



Model	Removable Shelves		Hinged Shelves Add	Capacity		Outside		Depth	Overall Height	Casters	
	*Virgin Polymer	Recycled Polymer		Cu. Ft.	Bu.	Length	Width			Arrangement	Data
87P	\$ 945	\$825	\$75	45	37	60	22	60	68	A, B	6-in. Rubber
88P	860	750	75	37	30	48	22	60	68	A, B	6-in. Rubber
91P	875	775	75	44	38	48	28 1/2	60	68	A, B	6-in. Rubber
92P	890	775	75	44	38	48	28 1/2	60	68	A, B	6 in. Rubber
95P	1,030	945	75	49	40	60	28 1/2	60	70	A, B	8-in. Rubber

Handles: \$25 each. Card Holder: \$25.00. Cart covers – see pages 10 - 11.

*Colors available: Pink, Wine, Red, Powder Blue, Cadet Blue, Royal Blue, Purple, Brite Lemon, Brilliant Orange, Beige, Chocolate Brown, Black, Lime Green, Jade Green, Forest Green, Honey Gold, Metallic Silver (Gray)

When ordering any of the above items, please specify if you want hand holes and/or drain holes.

SECURITY BULK DELIVERY/PICK-UP TRUCK

Ideal for Delivering Clean Linen and Pick-Up of Soiled Linen or Other Waste

Our newest security bulk delivery/pick-up truck, the **72S/SSL6** with rounded corners and larger inner ribs, combined with a recessed front door and top lid is especially suited for commercial laundries. This new ergonomically designed model has superior strength, durability, versatility, and security. It has an all new lockable, rotationally molded roof and front cover to prevent theft. The cart is leakproof so it may be transported and left outside. Ideal for commercial laundries, hospitals, nursing homes, resorts, health clubs, and the food industry.

Additional features are:

- Ergonomic cutaway design speeds loading and unloading
- Durable lid closure secures goods during transport and storage
- Rugged polyethylene construction resists bumps, scratches and scrapes
- Rotationally molded, full-perimeter, weatherproof poly base for strength and long life
- Large selection of industrial grade casters and arrangements (6" rubber standard)
- Optional tow hitches, brakes, hand holds are available
- 48 cubic foot capacity; 34 bushel capacity; 48" L x 28 1/2" W x 59" Deep x 66 1/2" Overall Height

Item #**72S/SSL6** with front door and split top lid (hinged in center) **\$955**

Also available with NO front door and NO lid, model #**72S** **\$650**

Please specify 4 swivel 6" casters (arrangement A) or 2 swivel/2 rigid 6" casters (arrangement B).

Add \$30 per cart for 8" casters.

Add \$15 for bottom drain valve, please specify if you want bottom drain holes omitted.

Add \$25 for hand holes.

Lid and front door are black.

*Colors available are listed at bottom of page. For recycled polymer—deduct \$50 from above prices.



72S Series
34 bushel capacity

Shown with top lid and front door open



101P ROUNDTRIPPER WITH PLASTIC NON-REMOVABLE SHELVES

37 Bushel Capacity, Yet Ideal for Narrow Spaces

The **all new 101P** is the most modern **ROUNDTRIPPER** cart available in the industry today. It features a breakthrough shelf conversion system that enables **one person** to switch the shelves from its horizontal clean linen delivery position to its vertical soiled linen return position **WITHOUT** removing the shelves. Since this truck is narrow (only 24" wide), it can fit up to four across in many trailers. The all plastic 101P is molded as a single unit, meaning there are no welds and no metal to weaken or rust over time. **Also available—102P with 600 lb. capacity available at \$925 per unit.**

Additional features are:

- Payloads up to 800 lbs.
- Weatherproof (optional covers, too)
- Industrial grade 6" rubber casters (8" also available)
- Costs less than metal carts
- In addition to our traditional colors listed below, the 101P is available in Sandstone or Gray Granite
- 46 cubic foot capacity: (37 bushel) 60 1/2" L x 24" W x 63 1/2" Deep x 71 1/4" Overall Height



Virgin Polymer—\$975 per cart



Clever hinge converts shelves to vertical, solid return position in seconds.

Please specify 4 swivel 6" casters (arrangement A) or 2 swivel/2 rigid 6" casters (arrangement B).

*Colors available: Pink, Wine, Red, Powder Blue, Cadet Blue, Brilliant Orange, Beige, Chocolate Brown, Lime Green, Jade Green, Royal Blue, Purple, Brite Lemon, Forest Green, Honey Gold, Metallic Silver (Gray), Black

When ordering any of the above items, please specify if you want hand holes and/or drain holes.



SECURITY LINEN EXCHANGE TRUCK

Self-Storing Roll-Top Door

Roll-Top Security Truck Model #640001S



- **Pilfer-Proof.** Secure containment prevents pilferage; lowers replacement costs. Patented white roll-top tambour door is self-storing; no hinges to interfere with storage and transport, even when open.
- **No More Cart Covers.** Goods stay sanitary and secure under the strong roll-top tambour door—made from the same durable polymers that resist weather and cracking in vinyl windows.
- **Lockable.** Rugged hardened steel hasp can lock door tight. Hidden metal reinforcements add strength and security.
- **Adjustable shelving.** Chrome-plated, heavy-duty wire or solid stainless steel; as many as needed, where needed.
- **Durability.** Seamless, one-piece, molded heavy-duty polyethylene; resists cracking and breaking. Industrial strength, non-marring 8" casters and steel base. Secure, rugged and adaptable.



Lockable steel hasp can lock door tight.



Model	Capacity	Outside Dimensions			Overall Height	Casters	Shipping Weight
		L	W	Depth			
640001S	48 cu. ft.	50"	29"	59"	69"	8"	200 lbs.

# 640001S	including two chrome plated shelves	\$1,345.00
Options:		
Additional shelves:	Chrome Plated	\$ 95.00
	Stainless Steel	160.00
Hand Holes (two each side) per truck		25.00
Card Holder		30.00
3/4" Drain Valve for this model		45.00

Also available with nylon cover (Model 1262S), with vinyl covering rather than roll top door—meets JCAHO requirements \$1,140.00

Please specify caster arrangement: 4 swivel or 2 swivel/2 rigid

Body Colors Available: Apple Red, Royal Blue, Cadet Blue, Beige, Orange, Silver Gray, Forest Green, Jade Green, Violet, Yellow, Chocolate Brown, White, Gray, Black.

Returns of security linen trucks are subject to a 25% restocking fee plus freight charges incurred.

MODEL 3000 UTILITY POLY SANITARY CART with Three Shelves



Top flap rolls down for security. Attaches with Velcro.

Ideal for Linen, Laundry, Medical Supplies

Lightweight, yet durable, easy rolling 30" length x 23" wide x 52" high, 15 cu. ft. capacity, four 5" swivel wheels, features a 5" deep recessed top tray, 3 shelves, two of which are removable. Cart is dent-proof, washable, rust proof, available in many colors.

Colors Available: Apple Red, Royal Blue, Cadet Blue, Beige, Orange, Silver Gray, Forest Green, Jade Green, Violet, Yellow, Choc. Brown, White, Gray, Black.

Cart is enclosed with a white or beige vinyl staphcheck roll-up cover which closes securely with full length Velcro strips.

#3000 with Roll-up Cover

1	2	3 or more
\$540.00 ea.	\$530.00 ea.	\$520.00 ea.

Optional Top Cover Available at \$45.00.

Optional Vinyl Hood Available at \$60.00.

Model 3000

Meets Joint Commission Requirements

See our website for a complete color chart

MODEL 2000 UTILITY POLY SANITARY CART with Two Shelves

Lightweight, yet durable, easy rolling 30" length x 23" wide x 43" high, 11 cu. ft. capacity, four 5" swivel wheels, features a 3" deep recessed top tray, 2 shelves. Cart is dent-proof, washable, rust proof, available in many colors.

Colors Available: Apple Red, Royal Blue, Cadet Blue, Beige, Orange, Silver Gray, Forest Green, Jade Green, Violet, Yellow, Choc. Brown, White, Gray, Black.

Cart is enclosed with a white or beige vinyl staphcheck roll-up cover which closes securely with full length Velcro strips.

#2000 with Roll-up Cover

1	2	3 or more
\$510.00 ea.	\$500.00 ea.	\$490.00 ea.

For quantities of more than six, please ask for our pricing.



Top flap rolls down for security. Attaches with Velcro.

Model 2000

Meets Joint Commission Requirements

FIVE EASY WAYS TO ORDER:

1. **By Mail:** P.O. Box 190 • Syosset, NY 11791

2. **Toll-Free:** 1-800-288-3547

3. **By Fax:** 1-516-367-4714

4. **By email:** LPCORP@aol.com

5. **Through our website:** www.LatestProducts.net



SINCE 1972, DISTRIBUTORS OF SPECIALTY ITEMS FOR HOSPITALS, NURSING HOMES, INSTITUTIONS

LATEST PRODUCTS CORP.

P.O. Box 190 • Syosset, New York 11791 • 1-800-288-3547 • Fax 1-516-367-4714 • email LPCORP@aol.com

LAUNDRY, HOUSEKEEPING, GENERAL UTILITY TRUCKS

Also Used by Thousands of Colleges and Universities on Move-In/Move-Out Day

NON-REPLACEABLE PERMANENTLY STITCHED LINER - Duck (Canvas) (D) or Vinyl (V)

Rust-proof bottom with body steel rods concealed in liner.

Vinyl (V) Gray, Orange, Black, White, Burgundy, Yellow, Red, Green, Blue Available

Ideal for Correctional Facilities. No Rods Exposed.

Leather Rim Top



#32 GM Heavy Duty Truck Comes with 3" casters

Bushels	Caster Size	Canvas Duck (D)	Vinyl (V)
6	3"	\$140.00	\$136.00
8	3"	154.00	149.00
10	3"	160.00	155.00
12	3"	175.00	170.00
14	3"	197.00	191.00
16	3"	201.00	195.00
18	3"	214.00	208.00
20	3"	243.00	241.00
24	4"	282.00	279.00

Note: 5" casters available for an extra \$30.00 per cart.

Cover caps and cart liners which prolong the life of carts are featured on page 39. Dimensions shown on top of next page.

Also available with lockable wood lid. See page 42, model #82.

More Vinyl Color Choices Now Available!

#22 TRUCK with Removable Replaceable Liner

Heavy Duty Duck (D) or 18 Oz. Vinyl Nylon Liner (V)

Plated Rust-Proof Frame and Bottom

Liners easily detached for washing and cleaning.

NEW!

Push N' Pull Handle for utility trucks now available - see page 28.



Removable Liner

Heavy Duty #22 Truck comes with 3" casters

CASTER ARRANGEMENTS AVAILABLE

A

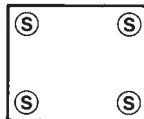

Corner mount (non-tilt)
4 swivel casters

B

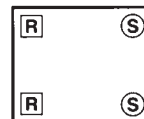

Corner mount (non-tilt)
2 rigid and 2 swivel casters

C

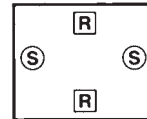

Diamond mount (tilt)
2 rigid and 2 swivel casters

Please Select Caster Arrangement as Shown Above

For Liners Please Specify

D = Duck (Canvas)

V = Vinyl (Gray) or colors listed below

Dimensions shown on top of next page.

Bushels	Caster Size	Canvas Duck (D)	*Vinyl (V) Gray, Orange, Black, White, Burgundy, Yellow, Red, Green, Blue Available
6	3"	\$144.00	\$141.00
8	3"	153.00	151.00
10	3"	161.00	157.00
12	3"	173.00	171.00
14	3"	184.00	182.00
16	3"	193.00	191.00
18	3"	199.00	197.00
20	3"	244.00	244.00

Note: 5" casters available for an extra \$30.00 per cart.

*Light duty collapsible vinyl trucks are now available in all bushel sizes.

Ships knocked down by UPS for reduced freight costs. Recommended for very light loads only. Call or email for pricing for collapsible vinyl trucks.

ELEVATED SPRING PLATFORM

Helps Prevent Strains by having linen rise to waist level



Bushel Capacity	# of Springs	#125 for Canvas/Vinyl	#125P for Molded
6	4	\$60.00	\$67.00
8	4	62.00	69.00
10	4	64.00	70.00
12	4	65.00	71.00
14	6	80.00	86.00
16	6	83.00	86.00
18	6	85.00	88.00
20	6	87.00	89.00
Springs only		14.00	15.00

See our website for a complete color chart !

LAUNDRY TRUCKS AND LINERS

Choose Heavy Duty Duck or 18 Oz. Vinyl Laminated Nylon Liners

Volume Bushels	Dimensions, Top ID ‡			Caster Size	Height Overall
	L (Top)	W (Top)	Depth		
6	30"	20"	20½"	3"	27"
8	34"	22"	23"	3"	29½"
10	36"	24"	25"	3"	31½"
12	36"	26"	27½"	3"	34"

‡ ID means Inside Dimensions.

Volume Bushels	Dimensions, Top ID ‡			Caster Size	Height Overall
	L (Top)	W (Top)	Depth		
14	40"	28"	27½"	3"	34"
16	40"	28"	30"	3"	36½"
18	42"	30"	30"	3"	36½"
20	48"	32"	30"	3"	36½"
24	54"	34"	30"	4"	37½"

These measurements are for 32GM and 22 Trucks as featured on opposite page.

CASTER ARRANGEMENTS AVAILABLE (Please specify)

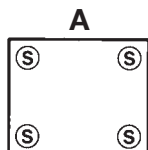

Corner mount (non-tilt) 4 swivel casters

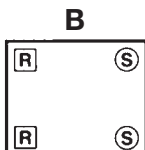

Corner mount (non-tilt) 2 rigid and 2 swivel casters
Our most popular

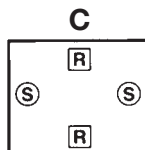

Diamond mount (tilt) 2 rigid and 2 swivel casters

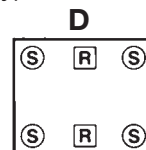

Full mount (tilt) 2 rigid and 4 swivel casters

SANITARY NYLON LINERS AND COVERS

Designed for transport and storage of clean or soiled linen. Made of heavy duty 200-denier white nylon. Easily laundered. Custom sizes available. Please provide your measurements.



No. 107 NY

No. 107 NY Basket Liner Without flap. Elastic in top hem.



No. 107 NYF

No. 107 NYF Basket Liner With cover flap and elastic in top hem.



No. 107 NYC

No. 107 NYC Nylon Cap or Cover With elastic in top hem. Keeps basket contents clean.

Available in other materials and colors – please inquire.

Bushel Capacity	No. 107 NY	No. 107 NYF	No. 107 NYC
	Nylon Liner	Nylon Liner With Top Flap	Top Covers or Caps Only
4	\$23.75	\$28.25	\$15.50
5	23.75	28.25	15.50
6	23.75	28.25	15.50
8	25.95	30.75	16.50
10	27.50	32.50	17.00

Bushel Capacity	No. 107 NY	No. 107 NYF	No. 107 NYC
	Nylon Liner	Nylon Liner With Top Flap	Top Covers or Caps Only
12	\$29.25	\$34.55	\$17.75
14	30.50	36.25	19.75
16	31.75	37.75	19.75
18	33.00	39.25	20.80
20	37.25	44.25	22.25

Help extend the life of your laundry trucks.

REPLACEMENT LINERS

will fit any standard oblong truck or basket



Liner #30



Minimum Order 2 Liners or \$75.00

Volume Bushels	Heavy-Duty Duck (Canvas)	Vinyl Nylon*
6	\$ 57.00	\$54.00
8	66.00	63.00
10	68.00	64.00
12	72.00	68.00
14	75.00	71.00
16	86.00	82.00
18	90.00	85.00
20	93.00	88.00
24	101.00	96.00

Order 4 or more Liners—Deduct 5%.

*Standard color is gray; also available in Yellow, Red, Green, Blue, Orange, Black, White and Burgundy at same price.

Please provide us with your email for monthly specials and new product bulletins.



SINCE 1972, DISTRIBUTORS OF SPECIALTY ITEMS FOR HOSPITALS, NURSING HOMES, INSTITUTIONS

LATEST PRODUCTS CORP.

P.O. Box 190 • Syosset, New York 11791 • 1-800-288-3547 • Fax 1-516-367-4714 • email LPCORP@aol.com

GENERAL MULTIPURPOSE TRUCKS

Manufactured from molded polyethylene. 3" industrial grade casters are standard and are available in three arrangements. 5" industrial casters also available for an additional \$30 per cart. Trucks come equipped with a galvanized pan base which is moisture resistant, and is ideal for laundries. Spring platforms, push-n-pull handles, inner liners, and top cover caps available. For sizes 12, 14 and 16 bushel we offer a unique polyethylene hinged lid, see model #139 which is featured on page 15. Free stenciling also available.

MODEL #22P INDUSTRIAL TRUCK WITH POLYETHYLENE LINER

Plated wire frame, rustproof bottom with replaceable polyethylene liner.



Model #	Capacity	Outside			Overall Height	Wall Thickness	
		Length	Width	Depth		.125	
22P-6	6 bushel	34	24	21	27		\$265.00
22P-8	8 bushel	37	26	23½	29½		275.00
22P-10	10 bushel	40	28	25	31		285.00
22P-12	12 bushel	40	30	28	34		295.00
22P-14	14 bushel	43	32	28	34		310.00
22P-16	16 bushel	43	32	30	36		340.00
22P-18	18 bushel	46	34	30	36		365.00
22P-20	20 bushel	51	35½	30	36		405.00

Nylon cap cover #107NYC featured on previous page. Above carts come with 3" casters; 5" casters also available at \$30 additional per cart.

MODEL #25 POLYETHYLENE LINER TO FIT ANY STANDARD BASKET OR LAUNDRY TRUCK



Model #	Capacity	Outside			Wall Thickness	
		Length	Width	Depth	.125	
25 x 6 Liner	6 bushel	34	24	21		\$ 95.00
25 x 8 Liner	8 bushel	37	26	23½		98.00
25 x 10 Liner	10 bushel	40	28	25		107.00
25 x 12 Liner	12 bushel	40	30	28		115.00
25 x 14 Liner	14 bushel	43	32	28		125.00
25 x 16 Liner	16 bushel	43	32	30		150.00
25 x 18 Liner	18 bushel	46	34	30		155.00
25 x 20 Liner	20 bushel	51	35½	30		162.00

MODEL #39 HEAVY DUTY TRUCK WITH GALVANIZED PAN BASE AND 3" CASTERS



Model #	Capacity	Outside			Overall Height	Wall Thickness	
		Length	Width	Depth		.225	.300
39-6	6 bushel	34	24	21	25	\$190.00	\$210.00
39-8	8 bushel	37	26	24	29	215.00	240.00
39-10	10 bushel	40	28	25	29	230.00	255.00
39-12	12 bushel	40	30	28	32	240.00	265.00
39-14	14 bushel	43	32	28	32	260.00	290.00
39-16	16 bushel	43	32	30	34	290.00	320.00
39-18	18 bushel	46	34	30	34	315.00	345.00
39-20	20 bushel	51	36	30	34	340.00	375.00

Nylon cap cover #107NYC featured on previous page. Above carts come with 3" casters; 5" casters also available at \$30 additional per cart.

Colors for #22P/25/39

Pink	Purple	Lime Green
Wine	Brite Lemon	Jade Green
Red	Brilliant Orange	Forest Green
Powder Blue	Beige	Honey Gold
Cadet Blue	Chocolate Brown	Metallic Silver (Gray)
Royal Blue	Black	

CASTER ARRANGEMENTS:

- A: Swivel at four corners
- B: Swivel at one end, fixed at other
- C: Diamond pattern, fixed on sides, swivel at ends (see previous page illustration)

Push N' Pull Handle for general multipurpose trucks featured on page 28

Our material handling experts are always available.
Call 1-800-288-3547 with any questions you might have.

LAUNDRY MULTIPURPOSE TRUCKS

Used Daily In Thousands of Facilities

EXTRACTOR TRUCK



Order as # 292

Extractor Truck
Rustproof Bottom
Replaceable Liner
Optional Spring Platform
available (see below)

Liner is 18 oz.
 Vinyl-Laminated Nylon or Canvas.
 Please specify.

4" All swivel casters are standard.

FLATWORK IRONER TRUCK



Order as # 302C

Flatwork Ironer Truck
Rustproof Bottom
Replaceable Liner
Comes with Spring Platform

Liner is 18 oz.
 Vinyl-Laminated Nylon.

5" all swivel casters are standard,
 other arrangements available.
 Spring platform is included in price.

SHEET FEED TRUCK



Order as # 312

Sheet Feed Truck
Rustproof Bottom
Replaceable Liner
Comes with Spring Platform

Liner is 18 oz.
 Vinyl-Laminated Nylon.

4" all swivel casters are standard.
 Truck and spring platform designed
 to reduce strain on operator by
 having linen rise to waist level.

292 Extractor Truck						302C Flatwork Truck						312 Sheet Feed Truck				
Inside Dimensions (inches)						Inside Dimensions (inches)						Inside Dimensions (inches)				
Style No.	Bushels	Top			Overall Ht.	Style No.	Bushels	Top			Overall Ht.	Style No.	Bushels	Top		Overall Ht.
		L	W	H				L	W	H				L	W	
1	20	60	32	24	31	1	10	44	23	23	32	1	24	84	24	32
2	24	60	32	27	34	2	12	50	23	23	32	2	28	84	24	36
3	28	70	32	27	34	3	14	56	23	23	32					

292 Extractor Truck

Style No.	White Canvas	Vinyl Nylon	Replacement Liner Canvas	Replacement Liner Vinyl Nylon	Optional Spring Platform
1	\$280	\$275	\$95	\$90	\$95
2	290	285	100	95	95
3	315	310	105	100	105

302C Flatwork Ironer Truck

Style No.	Vinyl Nylon	Repl. Platform	Repl. Liner
1	\$265	\$75	\$80
2	275	80	85
3	285	85	90

312 Sheet Feed Truck

Style No.	Vinyl Nylon	Repl. Liner	Repl. Platform
1	\$485	\$120	\$115
2	495	125	115

Standard vinyl color is gray—other colors available

FIVE EASY WAYS TO ORDER:

1. By Mail: P.O. Box 190 • Syosset, NY 11791

2. Toll-Free: 1-800-288-3547

3. By Fax: 1-516-367-4714

4. By email: LPCORP@aol.com

5. Through our website: www.LatestProducts.net



SINCE 1972, DISTRIBUTORS OF SPECIALTY ITEMS FOR HOSPITALS, NURSING HOMES, INSTITUTIONS

LATEST PRODUCTS CORP.

P.O. Box 190 • Syosset, New York 11791 • 1-800-288-3547 • Fax 1-516-367-4714 • email LPCORP@aol.com

LOCKABLE 1/2" PLYWOOD COVERED TRAVEL HAMPERS

Used by correctional institutions and where security is needed.
Also used in schools, locker rooms, and by theatrical companies.

**More Vinyl
Color Choices
Now Available!**



Locking Rod (standard)—comes with hamper and required if padlock is to be used.



Snap n' Chain to keep lid down (\$7 per set)
This item is not recommended for correctional institutions.

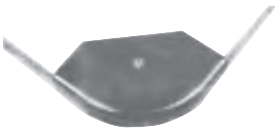

Corner Plates \$16.00 a set of 4.
Corner plates go on corners of lid.

Bushel Capacity	Inside Dimensions Length x Width x Depth	Duck Canvas	Gray*
		#82	Vinyl #82S
6	30 x 20 x 20½	\$196.00	\$193.00
8	34 x 22 x 23	218.00	212.00
10	36 x 24 x 25	239.00	234.00
12	36 x 26 x 27½	255.00	250.00
14	40 x 28 x 27½	276.00	270.00
16	40 x 28 x 30	280.00	274.00
18	42 x 30 x 30	294.00	288.00
20	44 x 32 x 33	310.00	306.00
24	54 x 34 x 30	422.00	416.00

Lock not included.

* Standard color is Gray for vinyl. Also available in Yellow, Red, Green, Blue, Orange, Black, White and Burgundy at same price.
Comes with 4 swivel corner 3" casters.
Add \$30 per cart for 5" casters.



Model #82

May also be used as a movable table.

Models #82 and 82S also available without lid – see page 38, Model #32GM.

- To secure the cover, these baskets come **standard with a locking rod** or optional "snap n' chain" set up.
- Replacement lock rods available for \$10.00.
- Replacement "snap n' chain" available for \$7.00 per set.

ELEVATED TRUCKS Standard with 2" Stem Casters



#152 Permanent Liners
Standard colors are white canvas or gray vinyl



#152-R (removable) shown.
#152-RS (vinyl) also available.

Bushel Capacity	Inside Dimensions Length x Width x Depth	Overall Height	#152, 152R	
			White Canvas	#152-S, 152-RS Gray Vinyl
3	24 x 18 x 16	27"	\$79.00	\$78.00
4	30 x 18 x 16	30"	\$87.00	\$86.00
6	30 x 20 x 20½	30"	\$99.00	\$98.00

For 3" stem casters add \$10 per cart.
Models with R have removable liners.
Other vinyl colors available, please inquire.

ELEVATED SPRING PLATFORM Helps prevent strains by raising contents to operator waist level



Bushel Capacity	# of Springs	#125 for Canvas Trucks	#125P for Molded Trucks
6	4	\$60.00	\$67.00
8	4	62.00	69.00
10	4	64.00	70.00
12	4	65.00	71.00
14	6	80.00	86.00
16	6	83.00	86.00
18	6	85.00	88.00
20	6	87.00	89.00
Springs only		14.00	15.00

POLY ELEVATED TRUCKS *Level and Slant Style frames** GREAT FOR DAMP LINEN STORAGE

2" Standard rubber swivel casters.



No. 652 with .100 thick liner

Bushel Size	Inside Dimensions Length x Width x Depth x Height	#652	#652-B	#652-B	#616 White
		White Only .100 thick	White Only .150 thick	Colors .150 thick	Top Cover Only .125 thick
2	22 x 14 x 14 x 27	\$ 84.00	\$ 91.00	\$ 95.00	—
3	24 x 18 x 16 x 27	97.00	103.00	105.00	\$33.00
4	30 x 18 x 16 x 30	105.00	110.00	113.00	42.00
6	30 x 20 x 20½ x 30	113.00	130.00	135.00	—

*Slant options are available on the four and six bushel frames only.
To add a drain fitting and hose on any "B" thickness basket, add \$50.00 to above prices.
3" diameter rubber swivel casters extra at \$10.00 per basket. 3" casters add 1" to overall height.
Standard polyliner color is white.



Level style frame Standard

TERMS: 2% ten days, net 30, F.O.B. Factory. We prepay shipping and add to invoice.

ALUMINUM LINEN SERVICE TRUCKS WITH DOORS OR FABRIC CLOSURE

Our aluminum carts are durable, yet lightweight. Ideal for use in hospitals, nursing homes, hospices, clinics, and other facilities where ample storage space, cleanliness and economy are important.

Sturdy, one-piece bodies—of airplane riveted 14-gauge aluminum sheet, with continuous door hinges. A continuous non-marking rubber bumper at the cart bottom is standard on all four sides of all carts. Double hinged doors open 270 degrees as shown below to provide easy access.

Flap closures are made of vinyl-coated fabric, highly resistant to abrasion and fire, with Velcro closure. Durable clear lacquer finish for long-lasting beauty and easy cleaning. Handles recessed at both ends to protect walls.



Two shelf design



Compartment design

FOR 25 TO 30 BED CAPACITY:

Two shelf design (shelves equally spaced)

LCD 125 with doors	\$3,495.00
LCD 125L with doors and lock	3,550.00
LCF 125 with vinyl-clad fabric closure	3,050.00
Weight: 210 lbs.	

Compartment design

LCD 116 with doors	\$3,495.00
LCD 116L with doors and lock	3,550.00
LCF 116 with vinyl-clad fabric closure	3,050.00
Weight: 200 lbs.	

FOR 30 TO 40 BED CAPACITY:

Two shelf design (shelves equally spaced)

LCD 128 with doors	\$3,710.00
LCD 128L with doors and lock	3,765.00
LCF 128 with vinyl-clad fabric closure	3,205.00
Weight: 230 lbs.	

Compartment design

LCD 121 with doors	\$3,540.00
LCD 121L with doors and lock	3,595.00
LCF 121 with vinyl-clad fabric closure	3,115.00
Weight: 220 lbs.	

OPTIONS:

Top Rail	\$290.00
Adjustable Shelves:	
For two shelf models	190.00
For compartment models	725.00
Bifold Doors	335.00

Dimensions shown are for cabinets only.

Outside dimensions include the rubber bumper which is 2" wide.

6" rubber casters, 2 swivel/2 rigid.

Casters add 7 1/2" to overall height.

Inside Dimensions (inches) (Body less Casters; View facing Truck)							
		LCD116, LCF116			LCD121, LCF121		
		H	L	W	H	L	W
Left Section	Top Compartment	9 1/4"	10 1/2"	20 1/2"	10 1/4"	18 1/2"	27 1/2"
	Center Compartment	17 1/4"	10 1/2"	20 1/2"	17 1/4"	18 1/2"	27 1/2"
	Bottom Compartment	18 3/4"	10 1/2"	20 1/2"	17 1/2"	18 1/2"	27 1/2"
Middle Section	Top Compartment	19 1/4"	20 1/4"	20 1/2"	20 3/4"	11 1/4"	27 1/2"
	Bottom Compartment	26 3/4"	20 1/4"	20 1/2"	25 1/4"	11 1/4"	27 1/2"
Right Section	Top Compartment	12 3/4"	10 1/2"	20 1/2"	10 1/4"	18 1/2"	27 1/2"
	Center Compartment	11 1/4"	10 1/2"	20 1/2"	17 1/4"	18 1/2"	27 1/2"
	Bottom Compartment	21 1/4"	10 1/2"	20 1/2"	17 1/2"	18 1/2"	27 1/2"
Outside		48"	48"	24"	48"	55"	31"

Inside Dimensions (inches) (Body less Casters; View facing Truck)							
		LCD125, LCF125			LCD128, LCF128		
		H	L	W	H	L	W
Inside (Three equal compartments)		15"	41 3/8"	20 1/2"	15"	48 3/8"	27 1/2"
Outside		48"	48"	24"	48"	55"	31"

We also offer a special aluminum truck (Model CS101) designed for central supply.

Quantity discounts available.

Call 1-800-288-3547 for a prompt, money-saving quotation.



SINCE 1972, DISTRIBUTORS OF SPECIALTY ITEMS FOR HOSPITALS, NURSING HOMES, INSTITUTIONS

LATEST PRODUCTS CORP.

P.O. Box 190 • Syosset, New York 11791 • 1-800-288-3547 • Fax 1-516-367-4714 • email LPCORP@aol.com

ERGONOMIC BULK LINEN CARTS

A wider and lower configuration than standard bulk linen carts. Our customers love less bending to reach contents and the wide opening allows for easy access. Available with or without cargo netting. Carts manufactured from waterproof, chemical resistant polyethylene.



72L (No Netting)



72N (With Netting)

Model	Capacity		Outside L x W (Inches)	Depth (Inches)	Overall Height (Inches)	1	2 or More
72L (No Netting)	48 cubic feet	38 bushels	48 X 28½	59	66½	\$755.00	\$730.00
72N (With Netting)	48 cubic feet	38 bushels	48 X 28½	59	66½	\$800.00	\$775.00

Regrind available, deduct \$50.00 per cart.

Please specify 4 swivel 6" casters (arrangement A) or 2 swivel/2 rigid 6" casters (arrangement B).

Colors available: Pink, Wine, Red, Powder Blue, Cadet Blue, Brilliant Orange, Beige, Chocolate Brown, Lime Green, Jade Green, Royal Blue, Purple, Brite Lemon, Forest Green, Honey Gold, Metallic Silver (Gray), Black

STARSYS™ ENCLOSED LINEN EXCHANGE CART

Polymer doors, sides and backs won't rust, dent, chip or peel. Enclosed environment provides efficient contamination-free handling and distribution of linens. Cart consists of four stationary shelves, non-locking 270 degree swing doors, 5" polyurethane swivel casters (two with brakes).

Shelf Width/Length (inches)	Approx. Height (inches)	Pkd. Wt. (lbs.)	Item No.	Price Each
22 x 40	76	312	SXRD76CM3	\$2,750.00

Outside cart measurements: 25" x 43" x 76"

Additional Shelves

Fits	Cat. No.	Price Each
Stationary Shelf	SXRDWQ	\$ 85.00 each
Full Extension Pullout	SXRDWAR	\$130.00 each



SXRD76CM3 Starsys Enclosed Linen Exchange Cart
Comes standard with 4 shelves.

FIVE EASY WAYS TO ORDER:

1. **By Mail:** P.O. Box 190 • Syosset, NY 11791
2. **Toll-Free:** 1-800-288-3547

3. **By Fax:** 1-516-367-4714
4. **By email:** LPCORP@aol.com

5. **Through our website:** www.LatestProducts.net

**Additional Stem
Caster Carts on
page 52.**

**Please also see our
new line of Suture
Carts on page 90.**

STEM CASTER, DOLLY CARTS AND SPECIALTY CARTS

Chrome Stem Caster Carts

**5 Tier Models
also available.
Please inquire.**

Four adjustable wire shelves, 5" Casters. All swivel or swivel with brakes.

Open-wire shelf design minimizes dust and increases air circulation and visibility.

With Chrome Shelves and Chrome-Plated Posts – 63" Posts — Overall Height 68"

Rubber casters can support 600 pounds – polyurethane casters can support 900 pounds and offer easier rolling. Chrome push handle – add \$35. Chrome extended handle – add \$45.

Shelf Width/Length (in.)	Approx. Pkd. Wt. (lbs.)	Four Swivel Resilient Rubber Casters		Two Swivel Two Brake Resilient Rubber Casters		Four Swivel Polyurethane Casters		Two Swivel Two Brake Polyurethane Casters	
		Price Each	Price Each	Price Each	Price Each	Price Each	Price Each		
18 x 36	60	A336AC	\$315.00	A336BC	\$325.00	A336DC	\$365.00	A336EC	\$375.00
18 x 48	72	A356AC	350.00	A356BC	360.00	A356DC	400.00	A356EC	410.00
18 x 60	88	A366AC	385.00	A366BC	395.00	A366DC	430.00	A366EC	440.00
21 x 36	69	A436AC	355.00	A436BC	365.00	A436DC	395.00	A436EC	405.00
21 x 48	81	A456AC	385.00	A456BC	390.00	A456DC	425.00	A456EC	435.00
21 x 60	98	A466AC	415.00	A466BC	425.00	A466DC	465.00	A466EC	470.00
24 x 36	76	A536AC	370.00	A536BC	380.00	A536DC	410.00	A536EC	425.00
24 x 48	92	A556AC	405.00	A556BC	415.00	A556DC	445.00	A556EC	460.00
24 x 60	112	A566AC	450.00	A566BC	460.00	A566DC	485.00	A566EC	495.00

Shipped knocked down for easy assembly. Enclosures for sides and back available at \$250/cart. Bottom solid shelf available either in stainless steel or galvanized at additional cost. We feature a large selection of cart covers; see pages 10 and 11. Available with solid shelves or stainless steel.

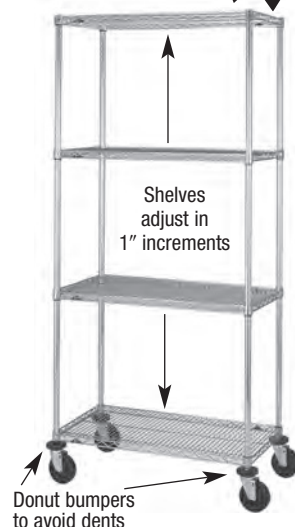

Wire Stem Caster Cart with adjustable shelves. Enclosure panels available.

Enclosed Chrome Slanted Shelf Trucks and Carts

Shelves slope backwards 2" to keep items from falling during transport. Standard-duty carts have four poly stem casters. Heavy-duty trucks are dolly mounted and have brakes.

Width/Length (in.)	Height* (in.)	Number of		Description	Approx. Pkd. Wt. (lbs.)	Cat. No.	Price Each
		Shelves	Casters				
24 x 36	62	3	6" 2 swivel/2 locking	Heavy-Duty	140	AST35MC	\$1,190.00
24 x 48	62	3	6" 2 swivel/2 locking	Heavy-Duty	162	AST55MC	1,235.00
24 x 60	62	3	6" 2 swivel/2 locking	Heavy-Duty	187	AST65MC	1,295.00
24 x 36	59	3	5"-Poly Casters	Standard-Duty	105	AST35DC	630.00
24 x 48	59	3	5"-Poly Casters	Standard-Duty	125	AST55DC	705.00
24 x 60	59	3	5"-Poly Casters	Standard-Duty	150	AST65DC	755.00

*Casters add approximately 6" to overall height.

Additional Slanted Shelves

Width/Length (in.)	Approx. Pkd. Wt. (lbs.)	Cat. No. Chrome	Price Each
24 x 36	13	SLT2436NC	\$80.00
24 x 48	17	SLT2448NC	90.00
24 x 60	22	SLT2460NC	95.00

**See pages
61-63 for
accessories**



Standard-Duty Slanted Shelf Cart with adjustable shelves. Bottom shelf only remains level.

Chrome Wire Dolly Trucks

With Chrome Shelves and wraparound bumper.

63" Plated Posts and Aluminum Dolly. 69" Overall height.

Shelf Width/Length (in.)	Approx. Pkd. Wt. (lbs.)	5" Casters Neoprene 2 swivel/ 2 brake	Catalog Number with Casters				8" Casters Polyurethane 2 swivel/ 2 lock/2 brake	Price Each
			Price Each	5" Casters Polyurethane 2 swivel/ 2 brake	Price Each	6" Casters Polyurethane 2 swivel/ 2 lock/2 brake		
18 x 36	78	N336JC	\$465.00					
18 x 48	92	N356JC	515.00	N356LC	\$555.00			
18 x 60	110	N366JC	560.00	N366LC	605.00			
21 x 36	88	N436JC	510.00					
21 x 48	104	N456JC	550.00	N456LC	595.00			
21 x 60	125	N466JC	600.00	N466LC	645.00			
24 x 36	96	N536JC	520.00	N536LC	565.00	N536MC*	\$835.00	
24 x 48	118	N556JC	570.00	N556LC	615.00	N556MC*	880.00	
24 x 60	142	N566JC	630.00	N566LC	670.00	N566MC*	940.00	
						N556PC*	\$885.00	
						N566PC*	935.00	

Dollies add 3/8" to the length of the unit and 3/8" to the width of the unit. Polyurethane (poly) supports a greater weight than Neoprene casters.

*For 6" and 8" models, brake lock/swivel lock controls are located on dolly for easy use!



Dolly Truck Enclosure panels available.

Custom configurations and sizes available on most of the above carts.



SINCE 1972, DISTRIBUTORS OF SPECIALTY ITEMS FOR HOSPITALS, NURSING HOMES, INSTITUTIONS

LATEST PRODUCTS CORP.

P.O. Box 190 • Syosset, New York 11791 • 1-800-288-3547 • Fax 1-516-367-4714 • email LPCORP@aol.com

LIFELINE CARTS

Used by thousands of hospitals and institutions. Advanced polymer construction, rounded corners and microban product protection to maintain a cleaner cart to improve infection control. Defibrillator platform adjusts to accommodate various size defibrillators. Lock controls for top compartments, drawers, and side bins. Two brake casters.



Cat. No. **LECCRP2**
Code Response Cart
\$1,975.00



Cat. No. **LECCRP3**
Code Response Cart
\$2,155.00



Cat. No. **LECCRP4**
Code Response Cart
\$1,995.00

See below for specific features of each cart.

- LECCRP2** 39" cart, 28 quart waste basket, Sharps container, adjustable defibrillator tray, backboard back assembly kit, oxygen tank holder, IV pole with mount, plastic security seals.
- LECCRP3** 39" cart with same features, but also with a top cavity tray, side bin, suction pump shelf, backboard front assembly kit, storage gel bin.
- LECCRP4** 42" cart with side bin, adjustable defibrillator tray, backboard front assembly kit, oxygen tank holder, IV pole with mount, plastic security seals.

MetroMax I.V. Transport/Storage System

The Perfect Solution For: Exchange System, Bulk Storage in Central Supply, Pharmacy Admixture, I.C.U. and E.R. Storage. Baskets have semi-open front for easy access. Dividers adjust horizontally within the basket to accept various sizes of I.V. bags. Continuous label holders identify basket contents.

Dimensions

Model No.	Description	Width (in.)	Length (in.)	Height (in.)	Total Baskets Per Cart	Casters	Price Each
MXIV1	Open Cart	24	24	60	4	*	\$1,120.00
MXIV2	Open Cart with Top Shelf	24	24	69	4	*	1,245.00
MXIV4	Open Cart	24	42	60	8	†	1,850.00
MXIV5	Open Cart with Top Shelf	24	42	69	8	†	1,950.00
MXIV6	Open Cart	24	60	60	12	†	2,400.00
MXIV7	Open Cart with Top Shelf	24	60	69	12	†	2,600.00

NOTE: Each basket sold with cart includes two dividers.

*Four 5" (127mm) poly casters; two swivel, two with brake.

†5" (127mm) poly casters on an aluminum dolly frame; two swivel, one swivel with brake, and one rigid.

Accessories

Description	Size (in.)	Cat. No.	Price Each
Basket* with Label Holder	18½ x 24½ x 10	IVB1	\$85.00
Divider	9	IVBD	\$20.00

*Basket weight capacity is 35 lbs.



MXIV1

IVB1
(shown with optional Divider)

Latest Products carries a complete line of suture carts, sterile wrap rack carts, catheter procedure carts, crash carts, and lab carts. Please call or email us for more details.

CHROME SECURITY STORAGE CARTS AND UNITS

Contents are visible and carts lock to protect against pilferage.

- Adjustable chrome wire shelves sold separately, see below.
- Double door – each door opens 270 degrees and can be secured at sides.
- Shipped knocked down to save on freight.
- Lock up valuables, syringes, medication, drugs, and supplies.
- Stainless steel models also available.

**Buy 2 or More,
Take 5% Off!**



SEC53DCQ shown with Intermediate Shelves (optional)

qwikSLOT Stationary Security Unit (no casters)

Width (inches)	Length (inches)	Height (inches)	Fits Shelf (inches)	Approx. Pkd. Wt. (lbs.)	Cat. No. Chrome	Price Each
21½	38½	66 ¹³ / ₁₆	18 x 36	138	SEC33CQ	\$ 740.00
21½	50½	66 ¹³ / ₁₆	18 x 48	157	SEC35CQ	905.00
27¼	38½	66 ¹³ / ₁₆	24 x 36	154	SEC53CQ	760.00
27¼	50½	66 ¹³ / ₁₆	24 x 48	174	SEC55CQ	935.00
27¼	62½	66 ¹³ / ₁₆	24 x 60	195	SEC56CQ	1,010.00

Buy 2 or more and take an additional 5% off.

qwikSLOT Mobile Security Cart

Standard-Duty Stem Caster Models: feature 5" swivel casters. Please note model numbers for specific caster types.

Caster Type	Width (inches)	Length (inches)	Height (inches)	Fits Shelf (inches)	Approx. Pkd. Wt. (lbs.)	Cat. No. Chrome	Price Each
(2) 5MP/(2) 5MPB	21½	40¾	68½	18 x 36	146	SEC33ECQ	\$ 875.00
(2) 5MP/(2) 5MPB	21½	52¾	68½	18 x 48	165	SEC35ECQ	1,055.00
(4) 5MP	27¼	40¾	68½	24 x 36	162	SEC53DCQ	890.00
(4) 5MP	27¼	52¾	68½	24 x 48	182	SEC55DCQ	1,075.00
(4) 5MP	27¼	65	68½	24 x 60	203	SEC56DCQ	1,150.00
(2) 5MP/(2) 5MPB	27¼	40¾	68½	24 x 36	162	SEC53ECQ	895.00
(2) 5MP/(2) 5MPB	27¼	52¾	68½	24 x 48	182	SEC55ECQ	1,080.00
(2) 5MP/(2) 5MPB	27¼	65	68½	24 x 60	203	SEC56ECQ	1,155.00

Casters: 5MP (swivel) and 5MPB (with locking brake) feature a polyurethane tread.

Note: Large casters can create a tipping hazard. On 18" security units, do not use casters larger than 5" in diameter.

Buy 2 or more and take an additional 5% off.

Heavy-Duty Models: feature aluminum dollies with wraparound bumpers and 5" diameter casters, two with brakes.

Caster Type	Width (inches)	Length (inches)	Height (inches)	Fits Shelf (inches)	Approx. Pkd. Wt. (lbs.)	Cat. No. Chrome	Price Each
(2) 5BP/(2) 5BPB	28 ³ / ₁₆	38½	68½	24 x 36	187	SEC53LCQ	\$1,120.00
(2) 5BP/(2) 5BPB	28 ³ / ₁₆	50½	68½	24 x 48	210	SEC55LCQ	1,310.00
(2) 5BP/(2) 5BPB	28 ³ / ₁₆	63¾	68½	24 x 60	235	SEC56LCQ	1,385.00

Intermediate Shelves for Security Units and Security Carts

Width (inches)	Length (inches)	Approx. Pkd. Wt. (lbs.)	Cat. No. Chrome	Price Each
18	36	8½	1836QBR	\$43.00
18	48	11¼	1848QBR	50.00
24	36	13	2436QBR	52.00
24	48	16	2448QBR	61.00
24	60	21	2460QBR	72.00



Clips snap easily into slots along post length to support shelves.



quikSLOT Locking Clip
Recommended for mobile applications. (Package of 4)
Cat. No. 9985QSL
Price \$10/pkg.

Stainless steel and antimicrobial models available, please inquire.
Shelving accessories available, see pages 61-63.
Cart covers available for all models, see pages 10-11.

We gladly accept Mastercard, Visa and American Express.



SINCE 1972, DISTRIBUTORS OF SPECIALTY ITEMS FOR HOSPITALS, NURSING HOMES, INSTITUTIONS

LATEST PRODUCTS CORP.

P.O. Box 190 • Syosset, New York 11791 • 1-800-288-3547 • Fax 1-516-367-4714 • email LPCORP@aol.com

**Buy 2 or more
and take an
additional
5% off.**

CHROME AND STAINLESS STEEL STANDARD DUTY UTILITY CARTS

3-Shelf Models

With adjustable shelves and 4" casters for
18" width and 5" casters for larger sizes, with overall 39" height.

MW Standard-Duty Utility Carts

MW200 Series — 3 Solid Shelves

Width/Length (in.)	Approx. Pkd. Wt. (lbs.)	Shelf Material	Handles	Cat. No.	Price Each
18 x 24	48	Stainless Steel	Stainless Steel	MW203	\$595.00
18 x 30	53	Stainless Steel	Stainless Steel	MW204	655.00
18 x 36	59	Stainless Steel	Stainless Steel	MW205	660.00
21 x 36	66	Stainless Steel	Stainless Steel	MW206	720.00
24 x 36	74	Stainless Steel	Stainless Steel	MW208	765.00



MW400 Series — 1 Solid, 2 Wire Shelves

Solid shelf can go on top, bottom or middle.

Width/Length (in.)	Approx. Pkd. Wt. (lbs.)	Shelf Material	Handles	Cat. No.	Price Each
18 x 24	43	Stainless Steel, Chrome	Chrome	MW401	\$295.00
18 x 30	47	Stainless Steel, Chrome	Chrome	MW402	335.00
18 x 36	52	Stainless Steel, Chrome	Chrome	MW403	340.00
21 x 36	59	Stainless Steel, Chrome	Chrome	MW404	365.00
24 x 36	65	Stainless Steel, Chrome	Chrome	MW406	385.00



MW700 Series — 3 Wire Shelves

Shelves and handles manufactured from materials shown below.

Width/Length (in.)	Approx. Pkd. Wt. (lbs.)	Shelf Material	Handles	Cat. No.	Price Each
18 x 24	39	Chrome	Chrome	MW701	\$225.00
18 x 24	38	Stainless Steel	Stainless Steel	MW702	565.00
18 x 30	43	Chrome	Chrome	MW703	240.00
18 x 30	42	Stainless Steel	Stainless Steel	MW704	620.00
18 x 36	47	Chrome	Chrome	MW705	245.00
18 x 36	45	Stainless Steel	Stainless Steel	MW706	625.00
21 x 36	50	Chrome	Chrome	MW707	275.00
21 x 36	50	Stainless Steel	Stainless Steel	MW708	705.00
24 x 36	60	Chrome	Chrome	MW711	260.00
24 x 36	57	Stainless Steel	Stainless Steel	MW712	745.00

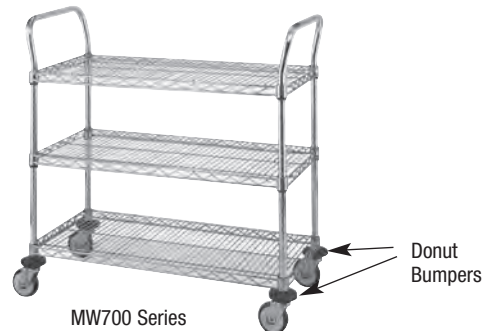

Cart Covers available for all MW Series with handle cut-outs.

Please Note: As the cost of raw materials and fuel escalate, all prices are subject to change without notice.

CHROME AND STAINLESS STEEL STANDARD DUTY UTILITY CARTS

2-Shelf Models

Buy 2 or more
and take an
additional
5% off.

MW Standard-Duty Utility Carts

- A durable, dependable transport solution that's easy to maneuver.
- Highly rigid construction lets you easily adjust shelves at 1" increments.
- Each cart consists of 2 handles, indicated number of shelves as shown, and casters. 18" wide carts have 4" light-duty casters and are 38" overall height. The 21" and 24" wide carts have 5" light-duty casters providing 375 lbs. of load capacity and are 39" overall height.
- Shipped knocked-down.

MW100 Series — 2 Solid Shelves

Width/Length (in.)	Approx. Pkd. Wt. (lbs.)	Shelf Material	Handles	Cat. No.	Price Each
18 x 24	40	Stainless Steel	Stainless Steel	MW103	\$445.00
18 x 30	45	Stainless Steel	Stainless Steel	MW104	495.00
18 x 36	48	Stainless Steel	Stainless Steel	MW105	505.00
21 x 36	54	Stainless Steel	Stainless Steel	MW106	545.00
24 x 36	60	Stainless Steel	Stainless Steel	MW108	575.00



MW100 Series

MW600 Series — 2 Wire Shelves

Width/Length (in.)	Approx. Pkd. Wt. (lbs.)	Shelf Material	Handles	Cat. No.	Price Each
18 x 24	34	Chrome	Chrome	MW601	\$190.00
18 x 24	34	Stainless Steel	Stainless Steel	MW602	415.00
18 x 30	37	Chrome	Chrome	MW603	200.00
18 x 30	37	Stainless Steel	Stainless Steel	MW604	475.00
18 x 36	40	Chrome	Chrome	MW605	210.00
18 x 36	39	Stainless Steel	Stainless Steel	MW606	480.00
21 x 36	44	Chrome	Chrome	MW607	220.00
21 x 36	44	Stainless Steel	Stainless Steel	MW608	530.00
24 x 36	47	Chrome	Chrome	MW611	225.00
24 x 36	46	Stainless Steel	Stainless Steel	MW612	560.00



MW600 Series

Cart covers with handle cut-outs available.

Do we have your email address? Please let us know so we can offer you our monthly email specials.



SINCE 1972, DISTRIBUTORS OF SPECIALTY ITEMS FOR HOSPITALS, NURSING HOMES, INSTITUTIONS

LATEST PRODUCTS CORP.

P.O. Box 190 • Syosset, New York 11791 • 1-800-288-3547 • Fax 1-516-367-4714 • email LPCORP@aol.com

PVC CERTIFIED NURSE AIDE CART



C-CNAC31

\$295.00

The cart nurse aides have always wanted. Their very own low cost supply cart for transporting anything they need for providing patient care. Beneath the top shelf writing surface, three roomy drawers and a bottom shelf afford ample space for all supplies.

- 44" H x 26" L x 16" W
- 3 drawers 7" H x 19" L x 14" W
- Weight: 37 lbs.
- Constructed of high quality pipe and polypropylene.
- 3 large supply drawers.
- 26" x 16" bottom storage shelf.
- Top shelf writing surface.
- 3" easy-roll casters, 2 locking.

PVC NURSING SUPPLY CART



C-NSC24

\$425.00

Mobile storage system for nursing supplies. A low cost, versatile cart to transport nursing supplies to all areas of the facility.

- 44" H x 30" L x 17½" W
- 4 drawers 7" H x 10½" L x 13" W
- 4 drawers 3" H x 10½" L x 13" W
- Weight: 50 lbs.
- 8 storage drawers in two sizes with top shelf writing surface.
- 30" x 18" bottom shelf for additional storage.
- Cart is lockable with swing-out gate, padlock not included.
- 3" easy-roll casters, 2 locking.

TERMS: 2% ten days, net 30, F.O.B. Factory. We prepay shipping and add to invoice.

PVC CLEAN LINEN CARTS

Attractive, Lightweight and Durable!

PVC Carts can be manufactured to your specific measurements. Contact us for details.



C-LC36-3 **\$445.00**
48" overall H x 40" L x 20" W (45 lbs.)
36" x 20" removable shelves with 12" spacing



C-MPC375 **\$430.00**
52" overall H x 31" L x 20" W (36 lbs.)
26" x 20" removable shelves with 14.5" spacing



C-LC46-3 **\$555.00**
64" overall H x 48½" L x 20" W (55 lbs.)
46" x 20" removable shelves with 16" spacing

OUR CLEAN LINEN CARTS FEATURE:

- New designed ergonomic push bars move easily throughout your facility—even when full.
- Cover opens on both sides for easy loading and unloading.
- Removable shelves and cover are simple to clean.
- 5" casters with 2 locking standard. Full locking 5" and 6" casters available.
- Covers are available in colors listed below.
- Various other sizes and customizable dimensions available. Call for details.

Our PVC clean linen carts come complete with a cart cover that opens from the front and back (double flap) which can be wiped clean. PVC is cost effective, retains its shine, will not stain and will not fade.

Choose from the following materials and colors:

Woven Mesh Material: Navy Blue, Royal Blue, Plum, Wineberry, Maroon, Silver, Mint Green, Forest Green, Teal, White, Linen.
Staphcheck Anti-Bacterial Material: Mint Green, Light Blue, Pink, White, or Teal/Blue Brushstroke.

Please Note: As the cost of raw materials and fuel escalate, all prices are subject to change without notice.



SINCE 1972, DISTRIBUTORS OF SPECIALTY ITEMS FOR HOSPITALS, NURSING HOMES, INSTITUTIONS

LATEST PRODUCTS CORP.

P.O. Box 190 • Syosset, New York 11791 • 1-800-288-3547 • Fax 1-516-367-4714 • email LPCORP@aol.com

MICROBAN PROTECTION STEM CASTER CARTS Corrosion Proof Polymer Construction with Stainless Steel Corners

- With built-in Microban® anti-microbial protection which inhibits the growth of bacteria, mold, mildew, and fungi that cause odors, stains and product degradation.
- Shelves adjust at 1/2" increments.
- Mats lift off for easy cleaning.
- Reinforced polymers offer incredible strength—800 lbs. capacity per shelf up to 48" length and 600 lbs. per shelf over 48" long.
- Many accessories available allowing you to customize your cart to your needs. Choose from shelf ledges, shelf dividers, side and back enclosure panels, cart covers, label holders. Please inquire about accessories.
- Latest Products will customize the cart to meet your facility's needs.

**Buy 2 or more
and take an
additional
5% off.**



Open-Grid Stem Caster Cart

Stem Caster Carts — Open Grid Shelves — 4 Tier — 69" Ht.

Catalog Number with 5" Casters

Shelf Width/Length (inches)	Approx. Pkd. Wt. (lbs.)	Cat. No. 2-Swivel 2-Brake		Cat. No. 2-Swivel 2-Brake	
		Resilient Rubber Casters	Price Each	Poly Casters	Price Each
18 x 36	74	X336BGX3	\$565.00	X336EGX3	\$610.00
18 x 48	86	X356BGX3	635.00	X356EGX3	685.00
18 x 60	98	X366BGX3	720.00	X366EGX3	765.00
24 x 36	82	X536BGX3	645.00	X536EGX3	690.00
24 x 48	98	X556BGX3	740.00	X556EGX3	785.00
24 x 60	114	X566BGX3	835.00	X566EGX3	880.00

Stem Caster Carts — Solid Bottom Shelf and 4 Open Grid Shelves — 5 Tier— 80" Ht.

- Approximate cart height—80". Weight capacity of cart is 900 lbs. evenly distributed.

Shelf Width/Length (inches)	Approx. Pkd. Wt. (lbs.)	Cat. No. 2-Swivel 2-Brake Poly Casters	Price Each
18 x 36	82	5X337EGX3	\$ 725.00
18 x 48	109	5X357EGX3	820.00
18 x 60	121	5X367EGX3	925.00
24 x 36	102	5X537EGX3	825.00
24 x 48	123	5X557EGX3	950.00
24 x 60	141	5X567EGX3	1,075.00



Solid Shelf Stem Caster Cart
Shown with optional extended handle. **\$65.00**

Ask us about additional handle options.

TERMS: 2% ten days, net 30, F.O.B. Factory. We prepay shipping and add to invoice.

IMPACT RESISTANT POLYMER UTILITY CARTS

Used by institutions to deliver and pickup everything from new or used linens, supplies, medical instruments, food and mail. Available in 2 shelf and 3 shelf configurations. Three models and three colors available.

Choice of: 16"x27" 20"x30" 26"x36"
 Choice of: Gray Black Blue* (*with built-in antimicrobial protection)

- Smooth surfaces easily wipe clean and won't stain.
- Sturdy construction designed to withstand daily abuse.
- Raised edge retains small spills and prevents items from sliding off during transport.

MY1627 Has easy grip handle and utility tray
 Small footprint (16" x 27" top tray) good for tight spaces
 4" non-marking swivel casters
 Includes four chrome posts

Cat. No.	Description	Dimensions	Capacity	Colors	Price
MY1627-2	2 Shelf model	18 ⁵ / ₁₆ x 21 ¹ / ₁₆ x 35 ⁵ / ₁₆	300 lbs.	Gray, Black, Blue*	\$150.00
MY1627-3	3 Shelf model	18 ⁵ / ₁₆ x 21 ¹ / ₁₆ x 35 ⁵ / ₁₆	400 lbs.	Gray, Black, Blue*	\$175.00

MY2030 Cart handle has built-in recessed support channel
 20 x 30 size accommodates most everyday items
 4" non-marking swivel casters
 Includes four chrome posts

Cat. No.	Description	Dimensions	Capacity	Colors	Price
MY2030-2	2 Shelf model	23 ¹ / ₂ x 34 ³ / ₁₆ x 35 ⁵ / ₁₆	300 lbs.	Gray, Black, Blue*	\$160.00
MY2030-3	3 Shelf model	23 ¹ / ₂ x 34 ³ / ₁₆ x 35 ⁵ / ₁₆	400 lbs.	Gray, Black, Blue*	\$195.00

MY2636 Cart handle has built-in slot to hold scanners
 26 x 36 large oversized tray is ideal for bulky items
 5" swivel resilient rubber casters included
 Includes four chrome posts

Cat. No.	Description	Dimensions	Capacity	Colors	Price
MY2636-2	2 Shelf model	27 ¹ / ₁₆ x 40 ¹ / ₄ x 36 ⁵ / ₁₆	400 lbs.	Gray, Black, Blue*	\$195.00
MY2636-3	3 Shelf model	27 ¹ / ₁₆ x 40 ¹ / ₄ x 36 ⁵ / ₁₆	500 lbs.	Gray, Black, Blue*	\$235.00

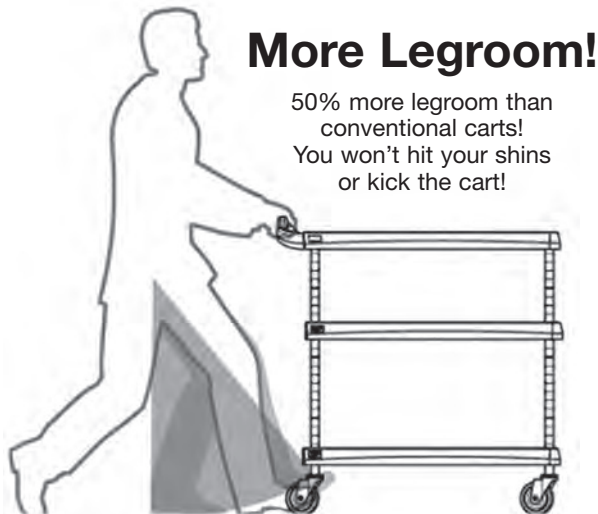

Easy & Useful

Easy-grip handle and roomy utility tray



We gladly accept Mastercard, Visa and American Express.



SINCE 1972, DISTRIBUTORS OF SPECIALTY ITEMS FOR HOSPITALS, NURSING HOMES, INSTITUTIONS

LATEST PRODUCTS CORP.

P.O. Box 190 • Syosset, New York 11791 • 1-800-288-3547 • Fax 1-516-367-4714 • email LPCORP@aol.com

Microban® Shelving units cost less than Stainless Steel with many of the same benefits!

MICROBAN® SHELVING UNITS



Two units joined together to save money shown above. See page 56 for details.

Adjustable sturdy epoxy coated wire shelving constructed with Microban® antimicrobial product protection

Protects against:

- Corrosion
- Bacteria
- Mold
- Mildew
- Fungi that cause odors, stains and product deterioration.

Use in areas such as food service, linen supply, housekeeping, or anywhere a sterile environment is needed.

- Easy to clean polymer shelf mats.

It's Easy to Adjust Shelves!



Lift the release at each corner to adjust shelf at 1" increments.

Units with 4 shelves and 4 posts – 63" overall height

Model No.	Size (63" Height)	1-2	3 or more
501 EM	18" W x 24" L x 63" H	\$320.00	\$310.00
502 EM	18" W x 30" L x 63" H	335.00	330.00
503 EM	18" W x 36" L x 63" H	345.00	335.00
504 EM	18" W x 42" L x 63" H	380.00	370.00
505 EM	18" W x 48" L x 63" H	395.00	385.00
505 AEM	18" W x 60" L x 63" H	425.00	415.00
506 EM	18" W x 72" L x 63" H	485.00	475.00
507 EM	21" W x 24" L x 63" H	360.00	350.00
508 EM	21" W x 30" L x 63" H	365.00	345.00
509 EM	21" W x 36" L x 63" H	370.00	360.00
510 EM	21" W x 42" L x 63" H	410.00	400.00
511 EM	21" W x 48" L x 63" H	420.00	410.00
512 EM	21" W x 60" L x 63" H	470.00	460.00
513 EM	21" W x 72" L x 63" H	550.00	540.00
514 EM	24" W x 24" L x 63" H	365.00	355.00
515 EM	24" W x 30" L x 63" H	390.00	380.00
516 EM	24" W x 36" L x 63" H	395.00	385.00
517 EM	24" W x 42" L x 63" H	460.00	450.00
518 EM	24" W x 48" L x 63" H	470.00	460.00
519 EM	24" W x 60" L x 63" H	530.00	520.00
520 EM	24" W x 72" L x 63" H	595.00	585.00

Units with 5 shelves and 4 posts – 74" overall height

Model No.	Size (74" Height)	1-2	3 or more
521 EM	18" W x 24" L x 74" H	\$375.00	\$360.00
522 EM	18" W x 30" L x 74" H	390.00	375.00
523 EM	18" W x 36" L x 74" H	400.00	385.00
524 EM	18" W x 42" L x 74" H	450.00	440.00
525 EM	18" W x 48" L x 74" H	460.00	450.00
526 EM	18" W x 60" L x 74" H	520.00	510.00
527 EM	18" W x 72" L x 74" H	580.00	570.00
528 EM	21" W x 24" L x 74" H	420.00	410.00
528 AEM	21" W x 30" L x 74" H	430.00	420.00
529 EM	21" W x 36" L x 74" H	440.00	430.00
530 EM	21" W x 42" L x 74" H	485.00	475.00
531 EM	21" W x 48" L x 74" H	495.00	485.00
531 AEM	21" W x 60" L x 74" H	555.00	545.00
531 BEM	21" W x 72" L x 74" H	655.00	645.00
532 EM	24" W x 24" L x 74" H	450.00	445.00
533 EM	24" W x 30" L x 74" H	455.00	450.00
534 EM	24" W x 36" L x 74" H	465.00	455.00
535 EM	24" W x 42" L x 74" H	545.00	535.00
536 EM	24" W x 48" L x 74" H	555.00	545.00
537 EM	24" W x 60" L x 74" H	625.00	615.00
538 EM	24" W x 72" L x 74" H	705.00	695.00

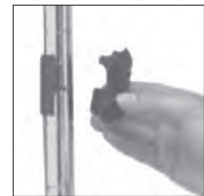

Sleeves & wedges attach easily to posts. No extra charge.

Shelving Unit Covers available. See pages 10 and 11.

Microban® antimicrobial product protection has an established performance record in many commercial, healthcare and food service settings. Microban® product protection is built-in during the manufacturing process and it is designed to last for the life of the product.

Microban® product protection utilizes an antimicrobial additive that is effective against a wide range of bacteria, mold and fungi. Microban® product protection has received NSF International Certification for food contact and water applications.

See following pages for chrome plated shelves.

Contact us for Microban® shelving unit accessories including dividers, ledges, side and back enclosure panels, label holders, shelf markers, baskets and more!



63" Height—four shelves

See
Pages 61 - 63
for Shelving
Accessories

CHROME PLATED SHELVING

Adjustable Shelving for Storage of:
Linen • Blankets • Gowns
Pillows • Cartons, Etc.

Select 63" or 74" height (Next page) and a variety of sizes.

All units consist of four posts, four shelves and are fully adjustable.

It's Easy to Adjust
Shelves!

Many other sizes available!

Model No.	Size (63" Height)	1-2	3 or more
101 EM	18" W x 24" L x 63" H	\$245.00	\$240.00
102 EM	18" W x 30" L x 63" H	250.00	245.00
103 EM	18" W x 36" L x 63" H	255.00	250.00
104 EM	18" W x 42" L x 63" H	285.00	280.00
105 EM	18" W x 48" L x 63" H	295.00	285.00
105 AEM	18" W x 60" L x 63" H	315.00	310.00
106 EM	18" W x 72" L x 63" H	365.00	360.00
107 EM	21" W x 24" L x 63" H	270.00	265.00
108 EM	21" W x 30" L x 63" H	275.00	270.00
109 EM	21" W x 36" L x 63" H	280.00	275.00
110 EM	21" W x 42" L x 63" H	310.00	305.00
111 EM	21" W x 48" L x 63" H	315.00	310.00
112 EM	21" W x 60" L x 63" H	350.00	345.00
113 EM	21" W x 72" L x 63" H	400.00	390.00
114 EM	24" W x 24" L x 63" H	280.00	275.00
115 EM	24" W x 30" L x 63" H	290.00	285.00
116 EM	24" W x 36" L x 63" H	295.00	290.00
117 EM	24" W x 42" L x 63" H	330.00	325.00
118 EM	24" W x 48" L x 63" H	335.00	330.00
119 EM	24" W x 60" L x 63" H	380.00	375.00
120 EM	24" W x 72" L x 63" H	425.00	420.00



Lift the release at each corner to adjust shelf at 1" increments.



Sleeves & wedges attach easily to posts. No extra charge.

Just a "Flick" of the Fingers
Lowers or Raises Shelving to
Desired Height.

Other sizes/configurations available as well as stainless steel shelving, mobile units and shelving covers.

Do we have your email address?

Please let us know so we can offer you our monthly email specials.



SINCE 1972, DISTRIBUTORS OF SPECIALTY ITEMS FOR HOSPITALS, NURSING HOMES, INSTITUTIONS

LATEST PRODUCTS CORP.

P.O. Box 190 • Syosset, New York 11791 • 1-800-288-3547 • Fax 1-516-367-4714 • email LPCORP@aol.com

See
Pages 61 - 63
for Shelving
Accessories

ADJUSTABLE CHROME PLATED STORAGE SHELVING

With 74" Height and Five Shelves

Ask us about our all new color
shelving units — available in 8 colors!



74" Height—five shelves

Model No.	Size (74" Height)	1-2	3 or more
121 EM	18" W x 24" L x 74" H	\$280.00	\$270.00
122 EM	18" W x 30" L x 74" H	285.00	275.00
123 EM	18" W x 36" L x 74" H	290.00	280.00
124 EM	18" W x 42" L x 74" H	330.00	320.00
125 EM	18" W x 48" L x 74" H	335.00	325.00
126 AEM	18" W x 60" L x 74" H	370.00	360.00
127 EM	18" W x 72" L x 74" H	430.00	420.00
128 EM	21" W x 24" L x 74" H	320.00	310.00
128 AEM	21" W x 30" L x 74" H	325.00	315.00
129 EM	21" W x 36" L x 74" H	330.00	320.00
130 EM	21" W x 42" L x 74" H	365.00	355.00
131 EM	21" W x 48" L x 74" H	370.00	360.00
131 AEM	21" W x 60" L x 74" H	415.00	405.00
131 BEM	21" W x 72" L x 74" H	480.00	470.00
132 EM	24" W x 24" L x 74" H	335.00	325.00
133 EM	24" W x 30" L x 74" H	345.00	335.00
134 EM	24" W x 36" L x 74" H	350.00	340.00
135 EM	24" W x 42" L x 74" H	390.00	380.00
136 EM	24" W x 48" L x 74" H	395.00	385.00
137 EM	24" W x 60" L x 74" H	445.00	435.00
138 EM	24" W x 72" L x 74" H	515.00	505.00

Other sizes/configurations available as well as
stainless steel shelving and mobile units.

Shelving Unit Covers available.
See pages 10 and 11.

See previous page for complete description of adjustable features.

Money Saving Idea

Expand your existing shelving by adding on additional shelves to existing unit. Using "S" hooks to attach—saves two posts. To compute costs, use the unit pricing for the size you need and deduct 5% for the posts not needed. S hooks included.

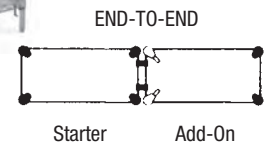

TERMS: 2% ten days, net 30, F.O.B. Factory. We prepay shipping and add to invoice.

STAINLESS STEEL HEAVY DUTY MULTI-PURPOSE TABLES

30 and 36 inches wide

Multi-Purpose Tables

Built for cleanliness and stability.

- Seamless 14-gauge stainless steel work surface and support structure.
- Shipped knocked down and can be assembled in minutes without tools.
- Accessories available include stainless steel drawers, stainless steel keyboard trays and swing arm for computer monitor.

All tables are 34" high and come with stationary posts and leveling feet and choice of bottom shelf, 3-sided frame or H-frame.



Process Table with H-Frame

Standard Process Tables — 30" Wide

Length (in.)	Post Material	Bottom Shelf Material	Bottom 3-Sided Frame Material	Bottom H-Frame Material	Cat. No.	Price Each
48	SS	SS	—	—	WT305FS	\$ 885.00
60	SS	SS	—	—	WT306FS	950.00
72	SS	SS	—	—	WT307FS	1,025.00
96	SS	SS	—	—	WT309FS	1,255.00
48	SS	—	SS	—	WT305US	725.00
60	SS	—	SS	—	WT306US	785.00
72	SS	—	SS	—	WT307US	860.00
96	SS	—	SS	—	WT309US	1,020.00
60	SS	—	—	SS	WT306HS	785.00
72	SS	—	—	SS	WT307HS	855.00
96	SS	—	—	SS	WT309HS	1,025.00

SS = Stainless Steel

Quantity discounts available — please inquire.



Process Table with optional Bottom Shelf which is adjustable in 2" increments

All tables — buy 2 or more and take an additional 5% off.

Standard Process Tables — 36" Wide

Length (in.)	Post Material	Bottom Shelf Material	Bottom 3-Sided Frame Material	Bottom H-Frame Material	Cat. No.	Price Each
60	SS	SS	—	—	WT366FS	\$1,090.00
72	SS	SS	—	—	WT367FS	1,170.00
96	SS	SS	—	—	WT369FS	1,410.00
60	SS	—	SS	—	WT366US	920.00
72	SS	—	SS	—	WT367US	995.00
96	SS	—	SS	—	WT369US	1,165.00
60	SS	—	—	SS	WT366HS	915.00
72	SS	—	—	SS	WT367HS	995.00
96	SS	—	—	SS	WT369HS	1,165.00

SS = Stainless Steel

Quantity discounts available — please inquire.



Process Table with 3-Sided Frame

**All tables manufactured of stainless steel.
Please contact us for non-stainless steel tables and additional sizes.
See page 58 for additional tables.**

FIVE EASY WAYS TO ORDER:

1. **By Mail:** P.O. Box 190 • Syosset, NY 11791

2. **Toll-Free:** 1-800-288-3547

3. **By Fax:** 1-516-367-4714

4. **By email:** LPCORP@aol.com

5. **Through our website:** www.LatestProducts.net



SINCE 1972, DISTRIBUTORS OF SPECIALTY ITEMS FOR HOSPITALS, NURSING HOMES, INSTITUTIONS

LATEST PRODUCTS CORP.

P.O. Box 190 • Syosset, New York 11791 • 1-800-288-3547 • Fax 1-516-367-4714 • email LPCORP@aol.com

Also ask us about all new polymer work tables!

STAINLESS STEEL HEAVY DUTY MULTI-PURPOSE TABLES

Standard Process Tables – 44" Wide

Length (in.)	Post Material	Bottom Shelf Material	Bottom 3-Sided Frame Material	Bottom H-Frame Material	Cat. No.	Price Each
60	SS	SS	—	—	WT446FS	\$1,185.00
72	SS	SS	—	—	WT447FS	1,265.00
96	SS	SS	—	—	WT449FS	1,500.00
60	SS	—	SS	—	WT446US	1,015.00
72	SS	—	SS	—	WT447US	1,085.00
96	SS	—	SS	—	WT449US	1,265.00
60	SS	—	—	SS	WT446HS	1,015.00
72	SS	—	—	SS	WT447HS	1,085.00
96	SS	—	—	SS	WT449HS	1,265.00

SS = Stainless Steel

Quantity discounts available – please inquire.

Mobile Process Tables on Wheels

All Mobile Process Tables are 34" high. Mobile units have special posts and four 5" poly casters – 2 swivel/2 brake.

Mobile Process Tables – 30" Wide

Length (in.)	Post Material	Bottom Shelf Material	Bottom 3-Sided Frame Material	Bottom H-Frame Material	Cat. No.	Price Each
48	SS	SS	—	—	MWT305FS	\$1,120.00
60	SS	SS	—	—	MWT306FS	1,180.00
72	SS	SS	—	—	MWT307FS	1,255.00
96	SS	SS	—	—	MWT309FS	1,485.00
48	SS	—	SS	—	MWT305US	955.00
60	SS	—	SS	—	MWT306US	1,015.00
72	SS	—	SS	—	MWT307US	1,085.00
96	SS	—	SS	—	MWT309US	1,255.00
60	SS	—	—	SS	MWT306HS	1,015.00
72	SS	—	—	SS	MWT307HS	1,085.00
96	SS	—	—	SS	MWT309HS	1,265.00

SS = Stainless Steel

Quantity discounts available – please inquire.

Process Tables with Utility Racks

All Process Tables with Overhead utility racks are 30" wide and have rear posts that are approximately 88" high. Cantilever shelves for overhead models are sold separately. Cantilever shelf adds convenient space above storage unit. Please inquire.

Length (in.)	Post Material	Bottom Shelf Material	Bottom 3-Sided Frame Material	Cat. No.	Price Each
60	SS	SS	—	WTC306FS	\$1,070.00
72	SS	SS	—	WTC307FS	1,150.00
96	SS	SS	—	WTC309FS	1,380.00
60	SS	—	SS	WTC306US	910.00
72	SS	—	SS	WTC307US	980.00
96	SS	—	SS	WTC309US	1,140.00

All overhead models are fitted with stationary posts and leveling feet.

SS = Stainless Steel



Process Table with H-Frame



Mobile Process Table with 3 sided frame

All tables – buy 2 or more and take an additional 5% off.



Process Table with Overhead Utility Rack

Please measure doors and areas carefully before ordering as all returns are subject to a 25% restocking fee, plus freight charges incurred.

SUPER HEAVY DUTY DUNNAGE RACKS

Mobile Dunnage Racks (Heavy Duty)

These easy-to-manuever racks feature two swivel and two swivel/brake casters; with non-marking 5" polyurethane tread casters.

- Support frames: 1" square tubing.
- Removable wire mat: 5/16" diameter wire.

All Dunnage Racks also available in anti-microbial material!



Mobile Dunnage Rack

Width/Length (in.)	Pkd. Wt. (lbs.)	Cat. No. Chrome	Price Each	Cat. No. Stainless	Price Each
18 x 36	42	MHP33C	\$370.00	MHP33S	\$645.00
18 x 48	50	MHP35C	405.00	MHP35S	760.00
24 x 36	48	MHP53C	380.00	MHP53S	685.00
24 x 48	54	MHP55C	415.00	MHP55S	810.00

Maximum distributed static load capacity is 800 lbs.

Note: These units are designed for only the 5HP and 5HPB casters, which are shipped assembled with the special posts.

HD Super Duty Dunnage Racks

Stores more than a ton safely off the floor.

- 48" rack has a 3,000 pound static load capacity (uniformly distributed); 60" rack carries up to 2,400 pounds.
- HD Super design features fast, secure assembly without tools.
- Posts of 1 5/8" diameter provide greater rigidity.
- HD Super™ Dunnage Racks are 16 1/4" high including cap and leveling bolt.

Buy 2 or more and take 5% off.



HD Super Dunnage Rack

Width/Length (in.)	Pkd. Wt. (lbs.)	Cat. No. Chrome	Price Each	Cat. No. Stainless	Price Each
18 x 48	52	HDP35C	\$395.00	HDP35S	\$795.00
18 x 60	62	HDP36C	455.00	HDP36S	925.00
24 x 48	57	HDP55C	420.00	HDP55S	860.00
24 x 60	66	HDP56C	475.00	HDP56S	995.00

Maximum capacity 2,400 pounds uniformly distributed static load on the 60" length racks; 3,000 pounds on the 48" length racks. **Note:** Capacity will be reduced and the unit will become less stable if the 3-sided frame is mounted higher than 6" from the floor.

HD Super Duty Dunnage Shelves

- 48" rack has a 3,000 pound static load capacity (uniformly distributed); 60" rack carries up to 2,400 pounds. H.D. 1 5/8" posts.
- Removable wire deck (5/16" diameter wire) lifts off for easy cleaning.
- Support frames: 1 1/2" square tubing. Removable deck.

Dunnage shelves can replace standard shelves for extremely heavy loads. Refer to storage shelving, pages 55-56.

Width/Length (in.)	Pkd. Wt. (lbs.)	Cat. No. Chrome	Price Each	Cat. No. Stainless	Price Each
18 x 48	35	1848HDRC	\$265.00	1848HDRS	\$590.00
18 x 60	43	1860HDRC	315.00	1860HDRS	695.00
24 x 48	38	2448HDRC	285.00	2448HDRS	640.00
24 x 60	47	2460HDRC	335.00	2460HDRS	760.00

Important: In stationary shelving, stability decreases as the ratio of height to width increases and when heavier loads are placed on upper shelves. Keep units as wide and low as possible, using the dunnage shelf as the bottom shelf. If two dunnage shelves are being used, both should be placed within the lower half of the unit.



STANDARD AND HEAVY DUTY DUNNAGE RACKS

Dunnage Platforms (Standard Duty)

Space-saving platforms let you keep bulky items off the floor.

- Open wire provides air circulation and minimizes dust.
- All platforms use 13P or 13PS posts — height 14⁵/₈" including mat, cap and leveling bolt.

Width/Length (in.)	Pkd. Wt. (lbs.)	Cat. No. Chrome	Price Each	Cat. No. Stainless	Price Each
18 x 24	11	P1824NC	\$80.00	P1824NS	\$230.00
18 x 30	12	P1830NC	82.00	P1830NS	232.00
18 x 36	14	P1836NC	83.00	P1836NS	234.00
21 x 24	12	P2124NC	86.00	P2124NS	252.00
21 x 30	13	P2130NC	88.00	P2130NS	255.00
21 x 36	15	P2136NC	89.00	P2136NS	257.00
24 x 24	13	P2424NC	88.00	P2424NS	265.00
24 x 30	15	P2430NC	89.00	P2430NS	268.00
24 x 36	17	P2436NC	91.00	P2436NS	270.00

Buy 2 or more and take 5% off.



Dunnage Platform

Dunnage Racks also available in anti-microbial material!

Dunnage Racks with Mat (Heavy Duty)

A space-efficient way to store large, bulky items off the floor.

- Removable top mat lifts off for cleaning.
- Dunnage racks are 14¹/₂" high including mat, cap and leveling bolt.

Width/Length (in.)	Pkd. Wt. (lbs.)	Cat. No. Chrome	Price Each	Cat. No. Stainless	Price Each
18 x 24	22	HP31C	\$160.00		
18 x 30	25	HP32C	170.00		
18 x 36	30	HP33C	175.00	HP33S	\$420.00
18 x 48	38	HP35C*	200.00	HP35S*	540.00
24 x 24	28	HP51C	175.00		
24 x 30	30	HP52C	185.00		
24 x 36	36	HP53C	190.00	HP53S	465.00
24 x 48	42	HP55C*	220.00	HP55S*	595.00



Dunnage Rack with Mat

Note: Maximum distributed static load capacity for stationary dunnage racks is 1,600 lbs., except on units marked * which have a 1,300 lb. capacity.

Dunnage Shelves (Heavy Duty)

Enhance the weight-bearing capacity of your system.

- 36" shelf holds 1,600 pounds (uniformly distributed); 48" shelves carry up to 1,300 pounds; 60" shelves bear up to 1,000 pounds.
- Removable wire mat: 5/16" diameter wire.
- Support frames: 1" square tubing lifts off for easy cleaning.

Width/Length (in.)	Pkd. Wt. (lbs.)	Cat. No. Chrome	Price Each	Cat. No. Stainless	Price Each
18 x 24	14	1824DRC	\$100.00		
18 x 30	18	1830DRC	110.00		
18 x 36	21	1836DRC	115.00	1836DRS	\$320.00
18 x 48	28	1848DRC	130.00	1848DRS	390.00
18 x 60	34	1860DRC	145.00	1860DRS	460.00
24 x 24	16	2424DRC	110.00		
24 x 30	20	2430DRC	120.00		
24 x 36	24	2436DRC	125.00	2436DRS	350.00
24 x 48	30	2448DRC	140.00	2448DRS	425.00
24 x 60	37	2460DRC	165.00	2460DRS	505.00

Dunnage shelves can replace standard shelves for extremely heavy loads.

Refer to storage shelving, pages 55-56.



Dunnage Shelf

Important: In stationary shelving, stability decreases as the ratio of height to width increases and when heavier loads are placed on upper shelves. Shelving stability is attained by keeping units as wide and low as possible, and placing heavy loads low on the shelving unit.

Please place us on your bid list for all products featured in this catalog or any housekeeping or laundry/linen products you use.

SHELVING ACCESSORIES TO ORGANIZE LINEN AND SUPPLIES

Bins

Convenient way to organize and identify small items.

- Hopper-front design allows for easy access and clear visibility.
- Lightweight, durable polypropylene and polyethylene bins have molded front slots to accept labels.

Shelf Bins — Nesting

These bins are sized to work on the two most popular shelf widths 18" and 24" for efficient handling and exchange.

Outside Dimensions Width/Length/Height (inches)	Approx. Pkd. Wt./Ctn. (lbs.)	Bin		Bin Color	Bin Cat. No.	Price Each	Divider Cat. No.	Divider Carton Quantity	Price Per Carton
		Carton Quantity	Color						
11 ⁵ / ₈ x 4 ¹ / ₈ x 4	9	24	Yellow	MB30120Y	\$ 4.00	MB40120	24	\$18.50	
11 ⁵ / ₈ x 6 ¹ / ₈ x 4	7	12	Yellow	MB30130Y	5.00	MB40130	24	23.00	
17 ¹ / ₈ x 4 ¹ / ₈ x 4	7	12	Yellow	MB30128Y	5.25	MB40120	24	18.50	
17 ¹ / ₈ x 6 ⁵ / ₈ x 4	9	12	Yellow	MB30138Y	7.50	MB40130	24	23.00	
17 ¹ / ₈ x 11 ¹ / ₈ x 4	15	12	Yellow	MB30178Y	17.00	MB40170	24	48.00	
23 ⁵ / ₈ x 4 ¹ / ₈ x 4	11	12	Yellow	MB30124Y	12.00	MB40120	24	18.50	
23 ⁵ / ₈ x 6 ¹ / ₈ x 4	8	6	Yellow	MB30164Y	15.00	MB40130	24	23.00	
23 ⁵ / ₈ x 11 ¹ / ₈ x 4	11	6	Yellow	MB30174Y	23.00	MB40170	24	48.00	

Note: Bins are available in carton quantities only. Bins above are priced per each, but must be ordered in multiples of carton quantity. (For example: MB30138Y is available in quantities of 12, 24, 36. Prices refers to the price of 1 bin.) Dividers are available in carton quantities only. Dividers are sold by the carton and priced by the carton. (For example: 1 MB40120 = 24 dividers, the price is for 24 dividers.)

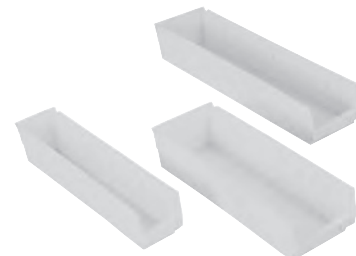

Shelf Bins — Nesting

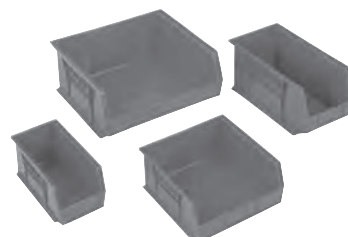

Supply Bins — Stacking

Supply Bins — Stacking

Stackable design maximizes vertical storage efficiency. Reinforced design adds strength and prevents spreading.

Outside Dimensions Width/Length/Height (inches)	Approx. Pkd. Wt./Ctn. (lbs.)	Bin		Bin Color	Bin Cat. No.	Price Each	Divider Cat. No.	Divider Carton Quantity	Price Per Carton
		Carton Quantity	Color						
10 ⁷ / ₈ x 5 ¹ / ₂ x 5	10	12	Blue	MB30230B	\$10.00	MB40230	6	\$17.00	
10 ⁷ / ₈ x 11 x 5	10	6	Blue	MB30235B	13.00	MB40230	6	17.00	
14 ³ / ₄ x 5 ¹ / ₂ x 5	13	12	Blue	MB30234B	15.00	N/A			
14 ³ / ₄ x 8 ¹ / ₄ x 7	24	12	Blue	MB30240B	16.00	MB40245	6	23.00	
14 ³ / ₄ x 16 ¹ / ₂ x 7	21	6	Blue	MB30250B	22.00	MB40245	6	23.00	
18 x 8 ¹ / ₄ x 9	17	6	Blue	MB30265B*	30.00	MB40265	6	37.00	
20 x 12 ³ / ₈ x 6	9	3	Blue	MB30281B*	28.00	N/A			
20 x 18 ³ / ₈ x 12	7	1	Blue	MB30283B*	49.00	N/A			

Note: MB30234B, MB30281B, MB30283B — no dividers available. Bins feature a full-width hanger lip that is designed for use with hanging systems. Bins are available in carton quantities only. Bins above are priced per each but must be ordered in multiples of carton quantity. (For example: MB30235B is available in quantities of 6, 12, 18. Price refers to the prices of 1 bin.) Dividers are available in carton quantities only. Dividers are sold by the carton and priced by the carton. (For example: 1 MB40230 = 6 dividers, the price is for 6 dividers.)



MB30283B



MB34240G

Bulk Supply Tub — Nesting

Ruggedly constructed, perfect for storing large bulky items.

Outside Dimensions Width/Length/Height (inches)	Approx. Pkd. Wt./Ctn. (lbs.)	Carton Quantity	Bin Color	Bin Cat. No.	Price Each

Note: Bins are available in carton quantities only. Bins above are priced per each, but must be ordered in multiples of carton quantity. (For example: MB34240G is available in quantities of 6, 12, 18. Prices refers to the price of 1 bin.)

Snap-On Hooks

Multi-purpose hooks in three styles attach to hanger rails, mounting rails or shelves for instant access.

Description	Height (in.)	Cat. No.		Price Each
		Chrome	Black	
Style A — Small	3 ⁷ / ₁₆	HK23C	HK23B	\$4.00
Style B — Large	3 ⁷ / ₁₆	HK25C	HK25B	5.00
Style C — Double	3 ⁷ / ₁₆	HK26C		7.00



Snap-on Hooks

Minimum accessory order is \$250 or a \$45 shipping charge will apply. You can achieve minimum order amount by ordering other products in our catalog.



SINCE 1972, DISTRIBUTORS OF SPECIALTY ITEMS FOR HOSPITALS, NURSING HOMES, INSTITUTIONS

LATEST PRODUCTS CORP.

P.O. Box 190 • Syosset, New York 11791 • 1-800-288-3547 • Fax 1-516-367-4714 • email LPCORP@aol.com

SHELVING ACCESSORIES TO ORGANIZE LINEN AND SUPPLIES

Label Holders - 1 1/4"

It's easy to identify shelf contents with these snap-on plastic holders, available in a variety of sizes. Labels not included. Gray.

Holds most commercial 1 1/4" labels.



1 1/4" Label Holder

Label Size (in.)	Fits Shelf Size (in.)	Cat. No.	Price Each
3 x 1 1/4	All	9990P	\$ 3.00
13 x 1 1/4	18	9990P1	4.15
19 x 1 1/4	24	9990P2	6.00
25 x 1 1/4	30	9990P30	6.75
31 x 1 1/4	36	9990P3	7.50
43 x 1 1/4	48	9990P4	9.40
55 x 1 1/4	60	9990P5	13.00

For Cantilever Shelves, use 3" label holder only.

Slanted Label Holders

Gray solid plastic holder puts 1 1/4" labels on slant for easier viewing.



Slanted Label Holder

Label Size (in.)	Fits Shelf Size (in.)	Cat. No.	Price Each
3 x 1 1/4	All	9990SL	\$ 3.00
13 x 1 1/4	18	9990SL1	4.15
19 x 1 1/4	24	9990SL2	6.00
25 x 1 1/4	30	9990SL30	6.75
31 x 1 1/4	36	9990SL3	7.50
43 x 1 1/4	48	9990SL4	9.40
55 x 1 1/4	60	9990SL5	13.00

For Cantilever Shelves, use 3" label holder only.

Clear Label Holders

Clear plastic allows decorator colors to show through. Holds most commercial 1 1/4" labels.



Clear Label Holder

Label Size (in.)	Fits Shelf Size (in.)	Cat. No.	Price Each
3 x 1 1/4	All	9990CL	\$ 3.00
13 x 1 1/4	18	9990CL1	4.15
19 x 1 1/4	24	9990CL2	6.00
25 x 1 1/4	30	9990CL30	6.75
31 x 1 1/4	36	9990CL3	7.50
43 x 1 1/4	48	9990CL4	9.40
55 x 1 1/4	60	9990CL5	13.00

For Cantilever Shelves, use 3" label holder only.

Dividers for Wire Shelves

Keep shelf contents orderly with these 8" high, snap-in-place dividers.



Shelf Divider - Wire Shelf

Shelf Width (in.)	Cat. No. Chrome	Price Each	Cat. No. Stainless	Price Each
14	DD14C	\$13.00	DD14S	\$37.00
18	DD18C	15.00	DD18S	40.00
21	DD21C	17.00	DD21S	45.00
24	DD24C	20.00	DD24S	49.00
30	DD30C	23.00	DD30S	59.00
36	DD36C	27.00	DD36S	70.00

Dividers for Solid Shelves

The easy way to keep shelves orderly. 8" high dividers attach with a spring clip.

Length (in.)	Cat. No. Chrome	Price Each	Cat. No. Stainless	Price Each
14	DD14FC	\$14.00	—	—
18	DD18FC	16.00	DD18FS	\$45.00
21	DD21FC	18.00	—	—
24	DD24FC	21.00	DD24FS	54.00



Shelf Divider - Solid Shelf

Ledges - Side and Back for Wire Shelves

For stationary or mobile installations, stackable ledges prevent items from protruding or falling.

Length (in.)	1" HIGH LEDGES				4" HIGH LEDGES			
	Cat. No. Chrome	Price Each	Cat. No. Stainless	Price Each	Cat. No. Chrome	Price Each	Cat. No. Stainless	Price Each
14	L14N-1C	\$ 9.00	L14N-1S	\$15.00	L14N-4C	\$12.00	L14N-4S	\$24.00
18	L18N-1C	10.00	L18N-1S	16.00	L18N-4C	13.00	L18N-4S	26.00
21	L21N-1C	11.00	L21N-1S	17.00	L21N-4C	14.00	L21N-4S	30.00
24	L24N-1C	12.00	L24N-1S	18.00	L24N-4C	15.00	L24N-4S	32.00
30	L30N-1C	13.00	L30N-1S	24.00	L30N-4C	17.00	L30N-4S	38.00
36	L36N-1C	14.00	L36N-1S	25.00	L36N-4C	20.00	L36N-4S	44.00
42	L42N-1C	15.00	L42N-1S	27.00	L42N-4C	24.00	L42N-4S	54.00
48	L48N-1C	16.00	L48N-1S	35.00	L48N-4C	25.00	L48N-4S	59.00
54	L54N-1C	18.00	L54N-1S	37.00	L54N-4C	26.00	L54N-4S	64.00
60	L60N-1C	19.00	L60N-1S	38.00	L60N-4C	27.00	L60N-4S	69.00
72	L72N-1C	20.00	L72N-1S	39.00	L72N-4C	30.00	L72N-4S	79.00

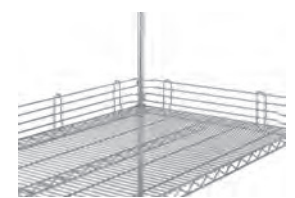

4" Ledges - Wire Shelf

Minimum accessory order is \$250 or a \$45 shipping charge will apply. You can achieve minimum order amount by ordering other products in our catalog.

SHELVING ACCESSORIES TO ORGANIZE LINEN AND SUPPLIES

Decorator Shelf Inlays

Hardboard mats prevent small items from falling through wire shelves. Fit between posts and level with top of shelf edge.

Width/Length (in.)	Description	Cat. No.	Price Each
14 x 36	Reversible, Black and White	1436BWI	\$23.00
14 x 48	Reversible, Black and White	1448BWI	24.00
18 x 24	Reversible, Black and White	1824BWI	23.00
18 x 36	Reversible, Black and White	1836BWI	24.00
18 x 48	Reversible, Black and White	1848BWI	25.00
24 x 24	Reversible, Black and White	2424BWI	24.00
24 x 36	Reversible, Black and White	2436BWI	27.00
24 x 48	Reversible, Black and White	2448BWI	28.00



Decorator Shelf Inlays

Clear Shelf Inlays

Nearly invisible plastic mat retains open-wire look of shelves and allows light penetration.

Width/Length (in.)	Cat. No.	Price 4-Pack	Width/Length (in.)	Cat. No.	Price 4-Pack
14 x 36	1436CI-4	\$46.00	21 x 36	2136CI-4	\$49.00
14 x 48	1448CI-4	53.00	21 x 48	2148CI-4	58.00
14 x 60	1460CI-4	64.00	21 x 60	2160CI-4	67.00
18 x 36	1836CI-4	47.00	24 x 36	2436CI-4	51.00
18 x 48	1848CI-4	56.00	24 x 48	2448CI-4	59.00
18 x 60	1860CI-4	65.00	24 x 60	2460CI-4	68.00



Clear Shelf Inlays

Ledges for Solid Shelves

Sturdy 4" high ledges contain items on shelves. Spring-clip tabs included.

Length (in.)	Cat. No. Chrome	Price Each	Cat. No. Stainless	Price Each
14	L14WC	\$13.00	L14WS	\$28.00
18	L18WC	14.00	L18WS	29.00
21	L21WC	15.00	L21WS	33.00
24	L24WC	16.00	L24WS	36.00
30	L30WC	21.00	L30WS	42.00
36	L36WC	22.00	L36WS	50.00
42	L42WC	23.00	L42WS	54.00
48	L48WC	26.00	L48WS	62.00
60	L60WC	28.00	L60WS	72.00



4" Ledges – Solid Shelf

Other accessories available—please inquire for pricing.



Chrome Baskets



Color Identification
Tubes



Display Hanger



Waterfall Hanger



Undershelf Slide



File Baskets

Minimum accessory order is \$250 or a \$45 shipping charge will apply. You can achieve minimum order amount by ordering other products in our catalog.



SINCE 1972, DISTRIBUTORS OF SPECIALTY ITEMS FOR HOSPITALS, NURSING HOMES, INSTITUTIONS

LATEST PRODUCTS CORP.

P.O. Box 190 • Syosset, New York 11791 • 1-800-288-3547 • Fax 1-516-367-4714 • email LPCORP@aol.com

HOUSEKEEPING AND MAID CARTS

HOUSEKEEPING CART

This versatile cart can carry everything you need to service 10-12 rooms. The 6" deep top tray helps prevent accidental spills of cleaning supplies. Complete with large collection bag, 10" casters to move easily over bumps and tracks and rubber bumpers on all corners to protect walls and furniture.

Locking doors optional—see M-Door pricing at bottom of page.

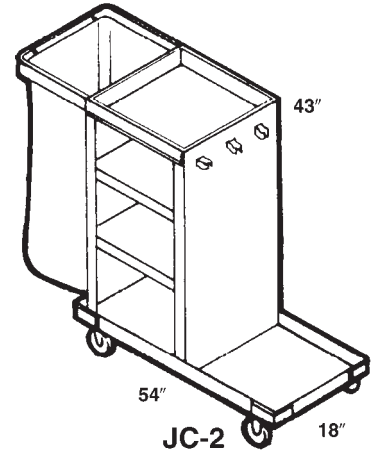
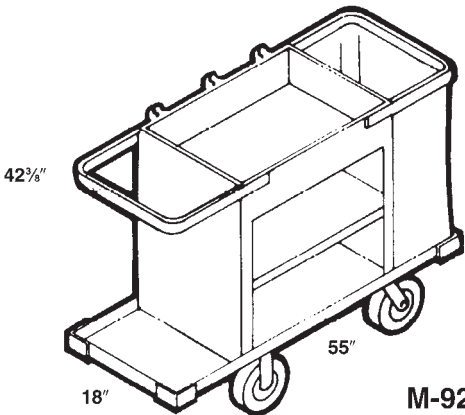

COMPACTS

Designed for economy. Sturdy enough for the toughest job. The compact size, easy storage and maneuverability make this cart perfect for smaller jobs and emergencies.

Locking doors optional—see JC and JCS-Door pricing at bottom of page.

- Quiet, 10" Casters, 2 Swivel, 2 Fixed
- Large Capacity Collection Bags Can Be Fitted to Both Ends
- Extra Deep Supply Tray
- Optional Locking Door
- Rubber Bumpers On All Corners
- Ships Knocked Down to Save Freight
- Manufactured from Silvertone Powder Coated Metal

- Designed for Simplicity, Economy
- Adjustable Shelves in Supply Compartment
- Optional Security of Locking Door
- Handle Telescopes for Easy Storage
- 4" Casters, 2 Swivel, 2 Fixed
- Clips & Hooks for Holding Utensils
- Epoxy Coated Tray to Resist Rust and Corrosion
- Large Capacity Collection Bag

CATALOG NUMBER	DESCRIPTION	WEIGHT	PRICE
M-92	Fixed Shelf, Body 18" W x 33" H x 31" L	105 lbs.	\$550.00
	Overall with Casters 18" W x 42 ³ / ₈ " H x 55" L		
	Complete with One Canvas White Bag or Blue Vinyl Bag		
M-Door	Baked Enamel Two Door Assembly with Flush Lock to Secure Contents of Supply Compartment on Model #M-92		\$120.00

CATALOG NUMBER	DESCRIPTION	WEIGHT	PRICE
JC-2	Fixed Platform, Comes with One Canvas White Bag or Blue Vinyl Bag – Sheet Metal Silvertone Powder Coated Metal	67 lbs.	\$375.00
JC-2 SS	Above Cart in Stainless Steel with One White Canvas Bag	76 lbs.	\$850.00
JC-Door	Baked Enamel Door with Flush Lock to Secure Contents of Supply Compartment on Models JC-2, JC-9, JC-10		\$105.00
JCS-Door	Above Door in Stainless Steel		\$175.00
JC-HH	Mop Handle Holder Attachment for JC-2, JC-9, JC-10		\$ 45.00

FIVE EASY WAYS TO ORDER:

1. By Mail: P.O. Box 190 • Syosset, NY 11791
2. Toll-Free: 1-800-288-3547

3. By Fax: 1-516-367-4714
4. By email: LPCORP@aol.com

5. Through our website: www.LatestProducts.net

HOUSEKEEPING AND MAID CARTS

FOLDAWAYS

Foldaway Janitorial Carts are designed for all around efficiency. The one or two bucket platforms fold up and the handle telescopes out of the way for storage.

The supply compartment has adjustable shelves for carrying supplies to the job site. Both the top tray and platforms are finished to prevent rust and corrosion.

- Manufactured from Silvertone Powder Coated Metal
- 4" Casters, 2 Fixed, 4 Swivel
- Fold-up Platform
- Optional Security of Locking Door for Supply Compartment
- Handle Telescopes for Easy Storage
- Hooks & Clips for Holding Utensils
- Epoxy Coated Tray and Platform
- Large Capacity Collection Bag



JC-10

CATALOG NUMBER	DESCRIPTION	PRICE
JC-10 72 Lbs.	Silvertone Powder Coated Folding 2 Bucket Platform White Canvas or Blue Vinyl Bag Platform Size = 33" x 18"	\$450.00
JC-10 SS 77 Lbs.	Stainless Steel Folding 2 Bucket Platform, White Canvas or Blue Vinyl Bag	825.00
JC-9 75 Lbs.	Silvertone Powder Coated Folding 1 Bucket Platform White Canvas or Blue Vinyl Bag Platform Size = 21" x 18"	425.00
JC-9 SS 80 Lbs.	Stainless Steel Folding 1 Bucket Platform, White Canvas or Blue Vinyl Bag	765.00

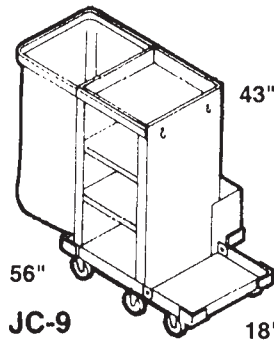

JC-9

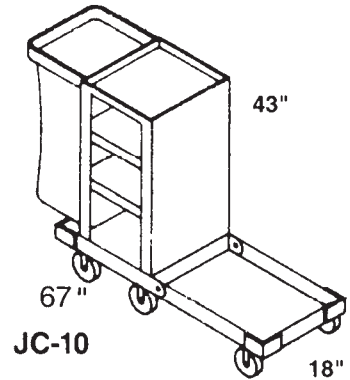

JC-10

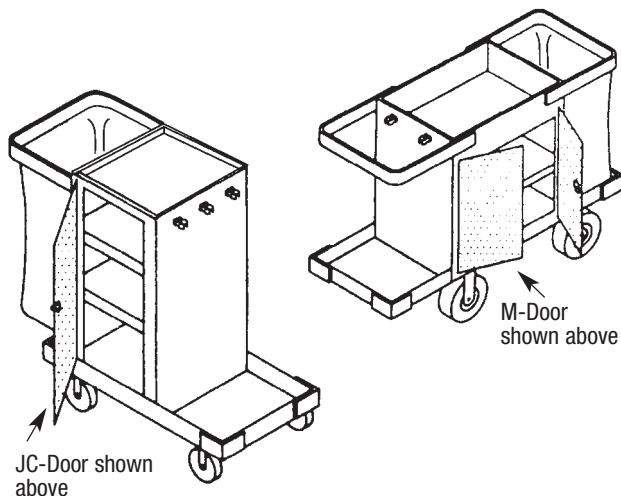

CART ACCESSORIES

CATALOG NUMBER	DESCRIPTION	PRICE
JC-Door	Baked Enamel Door with Flush Lock to Secure Contents of Supply Compartment on Models JC-2, JC-9, JC-10	\$105.00
JCS-Door	Above Door in Stainless Steel	175.00
M-Door	Baked Enamel Two Door Assembly with Flush Lock to Secure Contents of Supply Compartment on Model #M-92	120.00
JC-HH	Mop Handle Holder Attachment for JC-2, JC-9, JC-10	45.00

Please give us your email address so we can let you know of new products and monthly specials.



SINCE 1972, DISTRIBUTORS OF SPECIALTY ITEMS FOR HOSPITALS, NURSING HOMES, INSTITUTIONS

LATEST PRODUCTS CORP.

P.O. Box 190 • Syosset, New York 11791 • 1-800-288-3547 • Fax 1-516-367-4714 • email LPCORP@aol.com

HOUSEKEEPING, RECYCLING AND MAID CARTS

Ideal for Hospitals, Nursing Homes, Hotels, and Cruise Ships

HOUSEKEEPING/MAID CART – 3 SHELVES

Model #3200 – Can easily service 15 rooms. Lightweight yet made of heavy-duty poly construction. Has three shelves (two are removable) and an interior capacity of 14.5 cubic feet. On top, a 5" deep recess top tray permits convenient handling of small or tall items. Available with rugged vinyl bags for laundry and trash (priced separately). Rounded frames protect walls and people, and 8" casters ease movement. Options available are velcro-attached **Front Cover**, **Top Cover** and detachable **Hood** which provide additional protection from spillage, pilferage, and exposure to the elements.



Model #3200

Bags must be ordered separately.

MODEL #3200

Colors: Red, Royal Blue, Cadet Blue, Beige, Silver Gray, Forest Green, Jade Green, Brown, White, Black.

Casters: Specify 2 Swivel/2 Rigid or 4 Swivel.

1-3	4 or more
\$575.00	\$565.00

Soiled Linen Bags (12" x 21" x 31")
\$30 each (Tan)

Trash Bags (12" x 21" x 17")
\$24 each (Tan)

Available with velcro attached front cover – \$40; with top cover – \$35; top hood – \$50; corner bumpers – \$20; vacuum holder strap – \$4

Also available Model #2200 with 2 shelves – deduct \$25 when ordering two shelf model #2200.

Model	Capacity	Outside Dimensions			Overall Height	Casters	Shipping Weight
		L	W	Depth			
#3200	14.5 cu. ft.	56"	23"	46"	55"	8"	105 lbs.

If two shelves preferred – Model #2200 saves \$25.



Model #3250

COMPACT MAID CART

Model #3250 – Ideal for narrow hallways. The same interior and top capacity as Model #3200, this Compact Maid Cart is designed for tighter spaces with one deck and room for one heavy duty vinyl bag.

MODEL #3250

Same colors and options as Model #3200.

1-3	4 or more
\$575.00	\$565.00

Model	Capacity	Outside Dimensions			Overall Height	Casters	Shipping Weight
		L	W	Depth			
#3250	14.5 cu. ft.	46"	23"	46"	55"	8"	103 lbs.

UTILITY/RECYCLING CART

Model #521-HL

Linen and Waste Removal – Safe and Efficient – 21 cubic foot (17 bushel) capacity with hinged lid and latch for Joint Commission guidelines. Collect waste for disposal or recycling. Hinged lid permanently in place, eases loading from one side. Order royal blue for recycling or select from other colors as shown above. Six casters – 4 corner are swivel, 2 middle rigid.

(Unit available without lid as Model #521. Deduct \$125 for Model #521.)

MODEL #521-HL

1-3	4 or more
\$510.00	\$500.00



Model #521-HL

Model	Capacity	Outside Dimensions			Overall Height	Casters	Shipping Weight
		L	W	Depth			
#521-HL	21 cu. ft.	44"	29"	32"	39"	4"	85 lbs.

Please put us on your bid list for all laundry and housekeeping products.

COLLECTOR CARTS

To Pick Up Trash and Soiled Linen

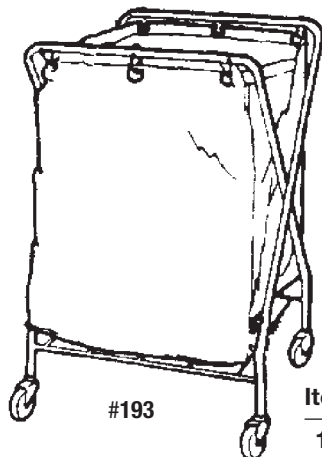

- Single bag collectors.
- Heavy chrome tubular steel frame and bottom platform for strength.
- Folds for convenient storage when not in use.
- Comes with a 6-bushel white nylon pak cloth bag or blue pak cloth bag.

Item #	Description	1	2	3+
193	Collector Truck – 24" L x 26" W x 36" H w/ 6 bu. white pak – cloth bag	\$245.00	\$235.00	\$225.00
193B	Collector Truck – 24" L x 26" W x 36" H w/ 6 bu. blue pak – cloth bag	255.00	245.00	235.00
114	White Pak – Replacement Cloth Bag – for 193 truck	77.00	75.00	73.00
115	Blue Pak – Replacement Cloth Bag – for 193 truck	87.00	85.00	83.00

ECONOMY MOLDED JANITOR CART

Janitor's Cart

- Manufactured from high impact structurally foamed polyethylene for strength and durability.
- Only cart that will hold a 20 or 32-gallon trash receptacle on the bottom platform; all other carts accommodate only 20-gallon receptacles.
- Specially designed hand holds for comfort and control that keeps hands out of trash.
- Adjustable center shelf.
- 8" heavy-duty wheels.
- Molded-in hooks for tools and mop handles.
- Handle folds for convenient storage.
- Non molded-in, replaceable bag hooks.
- All carts come with blue vinyl bag.
- 48" L x 20½" W x 38" H.



6850
(shown in use)

Item #	Description	Dimensions	Ctn. Pack	Ship Wt. Lbs./Ctn.	Price
6850	Janitor Cart – Gray, w/ 25-gallon blue vinyl bag	48" L x 20½" W x 38" H	1	36.0	\$165.00 each
6851	Blue vinyl replacement bag (25 gal. capacity)	18" L x 11" W x 27" H	1	1.5	35.00 each

Please give us your email address so we can let you know of new products and monthly specials.



SINCE 1972, DISTRIBUTORS OF SPECIALTY ITEMS FOR HOSPITALS, NURSING HOMES, INSTITUTIONS

LATEST PRODUCTS CORP.

P.O. Box 190 • Syosset, New York 11791 • 1-800-288-3547 • Fax 1-516-367-4714 • email LPCORP@aol.com

HOUSEKEEPING BUCKETS AND WRINGERS

Available in Plastic or Metal

Buy 3 or more buckets and wringers and take 5% off.



7y/2636-3y



6y/2635-3y



5y/2636-3y



4y/2635-3y



2000-260



PRO-Y



260 or WH350

Item #	Description	Capacity	Casters	Colors	Price
7y/2636-3y	#7000 plastic side press wringer/plastic bucket	26-35 quart	3"	Yellow	\$ 74.00 each
6y/2635-3y	#6000 plastic side press wringer/plastic bucket	26-35 quart	3"	Yellow, Blue, Gray	95.00 each
4y/2635-3y	#4000 plastic down pressure wringer/plastic bucket	26-35 quart	3"	Yellow, Gray	135.00 each
2000/260	#2000 metal squeeze wringer/metal bucket	26 quart	2"	Yellow	174.00 each
Pro-Y Pro-Pac	#2000 metal squeeze wringer/plastic bucket	26-35 quart	3"	Yellow	152.00 each
260	Oval galvanized steel bucket	26 quart	2"	Metal	98.00 each
WH350	Oval galvanized steel bucket	35 quart	2"	Metal	115.00 each



250 Mopping Tank with Two 12-1/2 Gallon Compartments

- Designed for moving large amounts of water and cleaning solution to isolated areas for big jobs.
- Constructed of heavy-duty galvanized and painted cold rolled welded steel.
- Equipped with #369 two-roller wringer with specially designed spring that easily adjusts pressure on the mop.
- Brass drain never corrodes or clogs.
- 2 compartments.
- Non-scuff vinyl bumper.

\$2,495 each. Also available with 15 or 30 gallon compartments.

Latest Products carries a complete line of janitorial and housekeeping items including mops, brooms, gloves, safety goggles, soap dispensers, electric hand dryers, wall-mounted ashtrays, sanitary napkin dispensers, and more. Please call or email us for more details.

POLY DUMP TILT TRUCKS



Sturdy full-perimeter black powder-coated steel underframe.



Trucks nest 2-high.



Split hinged lids

Model No.	Truck Price in Gray*	Capacity		Outside		Inside Depth	Overall Height	Wheels (Dia. x Width, in.)		Split Hinged Lid Cat. No.	Gray*
		Cu. Yds.	Lbs.	Length	Width			Two Front	Two Rear Swivel		
P-303H	\$590.00	5/8	1250	54	26	32	38	10 x 2	4 x 1 1/4	304	\$115.00
P-305H	645.00	1.1	2000	70	32	37	43	12 x 3	5 x 2	306	140.00
P-307H	790.00	1 1/2	2000	79 1/2	40 1/2	41 1/2	48 1/2	12 x 3	5 x 2	308	160.00
P-405H †	535.00	1	1300	70	32 1/2	37	44	12 x 3	5 x 2	405	140.00
P-405EH †	630.00	1	2200	70	32 1/2	37	44	12 x 3	5 x 2	405	140.00

*Other colors available at a small additional cost – please inquire.

Note: Models with "H" are heavy duty.

† New items.

Buy 3 or more, deduct 5% from above prices.

We offer a complete line of mops, buckets, wringers, and other housekeeping items. Please place us on your bid list.

RECYCLING CONTAINERS & RECYCLING CARTS

Great for Facilities Seeking “Green” Compliance

Latest Products Corporation offers a complete line of recycling receptacles, recycling containers and recycling carts. Our recycling products are found in hospitals, nursing homes, correctional facilities, assisted living facilities, colleges and universities, as well as for use by general industry. **Compare our prices and save!**

See Other Recycling Containers on pages 78 & 91



Model #15RT-1H
\$235.00



Model #15RT
\$250.00

One or Three Openings



Three Separate Plastic Liners



SMALL RECYCLING RECEPTACLE

Provides a pleasing single opening or 3-opening recycling container within a small area. Easy “lift-off” top. Choice of 3 colors. Durable all steel construction with a powder coated finish. Single opening comes with one plastic liner. Three opening comes with three 8 gallon liners. Recycling decals included. 24 gallon capacity.

Single Opening



Slot Opening

10/1



TALL ROUND RECYCLING CONTAINER WITH ROUND OR SLOT OPENING

Tall round recycling wastebasket & top with choice of 3” round opening or 8” slot opening. 20 gallon capacity. Blue or Black. Comes with recycle decal.

Model #10/1DTDB (round) \$75.00

Model #10/1STDB (slot) \$85.00

Item #	Colors	Diameter	Height
15RT	Black	15 in	32 in
	Blue		
	Green		
18RT	Black	18 in	33 in
	Blue		
	Green		
15RT-1H	Black	15 in	32 in
	Blue		
	Green		
18RT-1H	Black	18 in	33 in
	Blue		
	Green		
10/1DTDB	Blue, Black	16 in	30in
10/1STDB	Blue, Black	16 in	30in



Model #18RT-1H
\$270.00



Model #18RT
\$285.00

LARGE RECYCLING RECEPTACLE

Easy “lift-off” top with single opening or 3 openings for easy separation of recyclables. Single opening comes with one plastic liner. Three separate 11½ gallon plastic liners included for 3 opening container. All steel construction with a powder coated finish. Choice of 3 colors. Recycling decals included. 34½ gallon capacity.



SINCE 1972, DISTRIBUTORS OF SPECIALTY ITEMS FOR HOSPITALS, NURSING HOMES, INSTITUTIONS

LATEST PRODUCTS CORP.

P.O. Box 190 • Syosset, New York 11791 • 1-800-288-3547 • Fax 1-516-367-4714 • email LPCORP@aol.com

THE DEFENDERS® FOOT OPERATED STEP-ON CANS



Fire-safe steel with Uni-Koat® powder coated finish or #304 non-magnetic stainless steel construction. "No hands" foot pedal operation. Round models have galvanized steel liners and vinyl base rings for floor protection and reduction of noise. Square models have retainer bands that hold poly bags within the unit and are also available with a leakproof rigid plastic liner. Piano hinged lid mechanism protects walls and equipment. Steel legs feature nylon floor protectors.



Buy 8 or more receptacles and take an additional 5% off.

The Defenders medical step-on cans conform to OSHA standards on bloodborne pathogens for the safe containment of infectious waste and comply with OBRA Regulations. All models are UL Listed/Factory Mutual Systems Approved fire-safe/self-extinguishing and California State Fire Marshall Listed (except ST3.5 PL). All models are also manufactured of at least 30% recycled steel.

When "Quiet" operation is crucial, Silent Defenders are the solution.

The **NEW** Quiet Close design is available on all square Defenders® Step-On Can models with the same great features, benefits and durability.



Liner Code: PL = Rigid Plastic
GL = Galvanized Steel
RB = Retainer Band only

Sound Damper

POWDER COATED MODELS—Specify Red or White

DEFENDERS		SILENT DEFENDERS	
Model No.	Description	1-3	4+
ROUND MODELS WITH GALVANIZED STEEL LINERS			
ST3.5E GL/PL	3 1/2 Gal., 11" Dia. x 17" H	\$ 70.00	\$ 65.00
ST5E GL	5 Gal., 11" Dia. x 22" H	85.00	80.00
SQUARE MODELS WITH POLYBAG RETAINER BANDS			
ST7E RB	7 Gal., 12" Sq. X 17" H	110.00	100.00
ST12E RB	12 Gal., 12" Sq. x 23" H	120.00	110.00
ST24E RB	24 Gal., 15" Sq. x 30" H	145.00	135.00
ST40E RB	40 Gal., 19" Sq. x 30" H	185.00	175.00
SQUARE MODEL W/ HANDLE AND WHEELS			
ST40EW RB	40 Gal., 19" Sq. x 30" H	255.00	240.00
SQUARE MODELS PLASTIC LINERS			
ST7E PL	7 Gal., 12" Sq. X 17" H	125.00	115.00
ST12E PL	12 Gal., 12" Sq. x 23" H	150.00	140.00
ST24E PL	24 Gal., 15" Sq. x 30" H	180.00	170.00
ST40E PL	40 Gal., 19" Sq. x 30" H	240.00	230.00
SQUARE MODEL W/ PLASTIC LINER - HANDLE AND WHEELS			
ST40EW PL	40 Gal., 19" Sq. x 30" H	315.00	300.00

STAINLESS STEEL MODELS

DEFENDERS		SILENT DEFENDERS	
Model No.	Description	1-3	4+
ROUND MODEL WITH GALVANIZED STEEL LINERS			
ST3.5SS GL/PL	3 1/2 Gal., 11" Dia. x 17" H	\$145.00	\$135.00
SQUARE MODELS WITH POLYBAG RETAINER BANDS			
ST7SS RB	7 Gal., 12" Sq. X 17" H	205.00	195.00
ST12SS RB	12 Gal., 12" Sq. x 23" H	250.00	240.00
ST24SS RB	24 Gal., 15" Sq. x 30" H	350.00	340.00
ST40SS RB	40 Gal., 19" Sq. x 30" H	495.00	480.00
SQUARE MODEL W/ HANDLE AND WHEELS			
ST40SW RB	40 Gal., 19" Sq. x 30" H	595.00	580.00
SQUARE MODELS PLASTIC LINERS			
ST7SS PL	7 Gal., 12" Sq. X 17" H	220.00	210.00
ST12SS PL	12 Gal., 12" Sq. x 23" H	280.00	270.00
ST24SS PL	24 Gal., 15" Sq. x 30" H	390.00	375.00
ST40SS PL	40 Gal., 19" Sq. x 30" H	550.00	535.00
SQUARE MODEL W/ PLASTIC LINER - HANDLE AND WHEELS			
ST40SW PL	40 Gal., 19" Sq. x 30" H	645.00	630.00

Please include us on all hamper and step-on can bids.

ECONOMICAL HANDS FREE STEP-ON CANS

MEDI-CAN™ STEEL STEP-ON CANS



The economical solution for doctor's offices and clinics. Fire-safe steel construction. Tight fitting lid for maximum odor control. Foot pedal opens self-closing lid eliminating hand contact. Plastic base ring protects floor and deadens sound. Carrying handle permits easy placement. Equipped with a galvanized steel (GL) or rigid plastic (PL) liner. Complies with OSHA standards and OBRA regulations. Models offered in your choice of red or white powder coated finishes or stainless steel.

COMPLIES WITH
OSHA
STANDARDS

Description	Liners	Dimensions	Model No.	Colors	1-3	4 +	Model No.	Color	1-3	4 +
Round 1.5 Gallon	PL	8" Dia. x 11½" H	MST1.5E	White	\$40.00	\$38.00	MST1.5SS	Stainless	\$ 72.00	\$ 70.00
Round 3.5 Gallon	PL	10" Dia. x 15¼" H	MST3.5E	White, Red	50.00	48.00	MST3.5SS	Stainless	90.00	88.00
Round 8 Gallon	GL	11¼" Dia. x 25" H	MST7E	White	88.00	86.00	MST7SS	Stainless	140.00	136.00

Liner Code: PL = Rigid Plastic; GL = Galvanized Steel

**Buy 8 or more
receptacles and
take an additional
5% off.**

LABELS FOR HAMPER AND STEP-ON CAN IDENTIFICATION

Ensure proper waste disposal with these prominent bilingual labels designating the receptacle for Trash, Soiled Linen, Infectious Waste, or Biological Hazardous Material. Choose from six contents labels.



BP-1 (red background)



CD-1 (yellow background)



CL-1

**SOILED LINEN
ROPA SUCIA**

CL-2

**TRASH ONLY
BASURA SOLAMENTE**

CL-3

**INFECTIOUS WASTE
BASURA INFECCIOSA**

CL-4

CD-1	Chemotherapy Waste	(6" Square - Black/Yellow)
BP-1	Bio-Hazard	(6" Square - Black/Red)
CL-1	Bio-Hazard/Peligro Biologico	(7" H x 10" W - Black on White)
CL-2	Soiled Linen/Ropa Sucia	(4" H x 10" W - Black on White)
CL-3	Trash Only/Basura Solamente	(4" H x 10" W - Black on White)
CL-4	Infectious Waste/Basura Infecciosa	(4" H x 10" W - Black on White)

If ordered with cans
\$4.00 each
If ordered without can order
\$6.00 each
Minimum purchase is 12 labels

TERMS: 2% ten days, net 30, F.O.B. Factory. We prepay shipping and add to invoice.



SINCE 1972, DISTRIBUTORS OF SPECIALTY ITEMS FOR HOSPITALS, NURSING HOMES, INSTITUTIONS

LATEST PRODUCTS CORP.

P.O. Box 190 • Syosset, New York 11791 • 1-800-288-3547 • Fax 1-516-367-4714 • email LPCORP@aol.com

PLASTIC RECEPTACLES AND ACCESSORIES

Gator Container & Accessories

- Gator containers meet and surpass all other heavy duty plastic containers in every category.
- Molded with highest quality polyethylene resin.
- One piece molded construction creates high impact and crush resistance.
- With its lock down lid, the container is animal and spill resistant, lid stays on even if container is tipped over.
- Offset ridge design allows container to nest without jamming.
- Gator handles have a larger radius and deeper well, making the container more comfortable to lift and move.
- Colors as indicated.

Gator Caddy

- Water resistant.
- Caddy aprons around container.
- Nine pouches for cleaning supplies.
- Fits 32 and 44 gallon containers.

Gator Dolly

- Structural foam molded, extremely durable.
- Five 3" swivel casters, extremely stable.
- Securely attaches to 20, 32, 44, and 55 gallon Gators.
- Gator dolly fits competitors' containers.
- Only dolly with vents to keep from suctioning to container.

Thin Bin

High capacity container designed for tight places.

- 23 gal. capacity.
- Convenient ergonomic designed handles.
- Recessed hand grips molded into bottom for easy emptying.
- Textured finish outside for attractive, commercial look.
- Smooth inside surface for easy cleaning.
- Constructed of durable polyethylene blend.

**Buy \$250.00
in receptacles
and take
5% off.**



7744 w/7745
Container with lid

7732 w/7733
Container with lid

7720 w/7721
Container with lid

7710 w/7711
Container with lid



7704 Dolly



7705 Vinyl Caddy



7023 Thin Bin
Container

Item #	Description	Dimensions	Color	Ctn. Pack	Ship. Wt. Lbs./Ctn.	Price Each
7710	10-gallon, Gator container	15 ⁷ / ₈ " Dia. x 17" H	White, Gray	6	16.0	\$ 14.00
7711	10-gallon, Gator lid	16" Dia. x 1 ³ / ₁₆ " H	White, Gray	6	5.5	9.50
7720	20-gallon, Gator container	19 ¹ / ₄ " Dia. x 23 ¹ / ₈ " H	Gray, White, Blue	6	36.0	25.00
7721	20-gallon, Gator lid	19 ¹ / ₂ " Dia. x 1 ¹ / ₈ " H	Gray, White, Blue	6	9.1	10.00
7732*	32-gallon, Gator container	21 ³ / ₄ " Dia. x 27 ³ / ₈ " H	Gray, Yellow, White, Blue, Green	6	56.0	37.00
7733	32-gallon, Gator lid	22" Dia. x 1 ¹ / ₄ " H	Gray, Yellow, White, Blue, Green	6	12.0	14.00
7744	44-gallon, Gator container	23 ³ / ₄ " Dia. x 31 ⁵ / ₈ " H	Gray, Yellow, White, Blue, Red	4	53.0	64.00
7745	44-gallon, Gator lid	24" Dia. x 1 ³ / ₈ " H	Gray, Yellow, White, Blue, Red	4	11.0	22.00
7755	55-gallon, Gator container	26 ³ / ₄ " Dia. x 33" H	Gray	3	52.0	110.00
7756	55-gallon, Gator lid	27 ¹ / ₄ " Dia. x 2 ¹ / ₂ " H	Gray	3	12.75	38.00
7705	Caddy, fits 32 & 44-gallon Gators	20" Dia. x 20 ¹ / ₂ " H	Yellow	6	7.8	38.00
7704	Dolly	17 ⁷ / ₈ " Dia. x 6 ⁹ / ₁₆ " H	Black	2	15.0	42.00
7708	Anchor no-tilt dolly	24" Dia. x 7" H	Black	2	17.0	44.00
7023*	23-gallon, thin bin container	11" L x 23" W x 30" H	Beige, Gray, Brown, Blue	4	28.0	40.00
7024	23-gallon, thin bin lid	20 ¹ / ₄ " L x 11 ³ / ₁₆ " W x 4 ¹ / ₂ " H	Beige, Gray, Brown	4	10.4	28.00

*7732 and 7023 available with imprinted recycle logo, add \$3.00 per receptacle.

**Minimum receptacle and accessory order for these items – \$100.
No broken cartons please.**

We offer a complete line of mops, buckets, wringers, and other housekeeping items. Please place us on your bid list.

DECORATIVE RECEPTACLES

HALF ROUND RECEPTACLES

Space saving semicircular flat top and open top receptacles are an elegant alternative to traditional receptacles when aesthetics are important and space is limited. Fire-safe steel construction with bottom rim designed to protect floors. Protective vinyl trim on all openings. Leakproof rigid plastic liner. Lift-off body facilitates easy emptying. Available in Satin Stainless Steel (SSS) and Black with Chrome accents (20B). Manufactured using 30% recycled steel.



Model No.	Dimensions	Capacity	Price Each	
			1-5	6 or more
SO12SSS	32" H x 18" W x 9" D	12 gal.	\$330.00	\$320.00
SO1220B	32" H x 18" W x 9" D	12 gal.	180.00	170.00
SO8SSS	32" H x 15" W x 9" D	9 gal.	280.00	270.00
SO820B	32" H x 15" W x 9" D	9 gal.	165.00	155.00

SC18SMPL

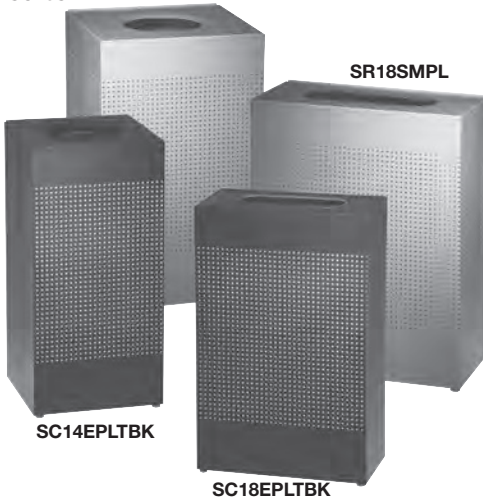

SILHOUETTES

Heavy gauge steel construction and graphic perforations combine to create a sleek, modern, fire-safe design. Durable Silver Metallic (SM) powder coated finish offers the look of stainless steel and resists fingerprints, also available in Textured Black (TBK). Folding retainer bands secure poly bag out of sight. Convenient hinged top for easy emptying. Leg levelers provide stable placement. Leakproof rigid plastic liner. Manufactured using 30% recycled steel.

Model No.	Dimensions	Capacity	Price Each	
			1-5	6 or more
SC14SMPL	30" H X 14.75" W X 14.75" D	16 gal.	\$330.00	\$320.00
SC18SMPL	30" H X 18.75" W X 18.5" D	29 gal.	430.00	420.00
SR14SMPL	30" H X 19.5" W X 10" D	13 gal.	360.00	350.00
SR18SMPL	30" H X 24" W X 12.5" D	22.5 gal.	465.00	455.00
SC14EPLTBK	30" H X 14.75" W X 14.75" D	16 gal.	330.00	320.00
SC18EPLTBK	30" H X 18.75" W X 18.75" D	29 gal.	395.00	385.00
SR14EPLTBK	30" H X 19.5" W X 10" D	13 gal.	330.00	320.00
SR18EPLTBK	30" H X 24" W X 12.5" D	22.5 gal.	425.00	410.00

ECLIPSE

Sleek smooth curves and gleaming finishes in heavy gauge fire-safe steel or non-magnetic stainless steel. Large 30 gallon capacity with an open top design for "hands-free" drop in convenience in high traffic areas. Curved top deters accumulation of debris around 9.5" x 11.5" disposal opening. Top lifts off for easy emptying of leakproof rigid plastic liner. Recessed base ring allows for ease in cleaning under unit. Standard models are available with durable Black Uni-Koat powder coated finish or Satin Stainless Steel. Customize with decals or transfers or choose from over 180 custom colors. 2 year limited warranty.



Model No.	Color	Price Each	
		1-5	6 or more
R2030E	Black	\$350.00	\$340.00
R2030SS	Stainless Steel	595.00	585.00

Our decorative receptacles are found in the entrances, lobbies and hallways of hospitals, nursing homes and office buildings.



SINCE 1972, DISTRIBUTORS OF SPECIALTY ITEMS FOR HOSPITALS, NURSING HOMES, INSTITUTIONS

LATEST PRODUCTS CORP.

P.O. Box 190 • Syosset, New York 11791 • 1-800-288-3547 • Fax 1-516-367-4714 • email LPCORP@aol.com

OUTDOOR RECEPTACLES

Used at thousands of facilities nationwide

- Durable powder coated, hot-dipped galvanized steel construction withstands the elements.
- Leakproof rigid plastic liners make maintenance a snap.
- Available in UV Stabilized Standard black powder coated finish.
- ADA compliant.
- Model R36HTSBK is equipped with adjustable leg levelers for stability on uneven surfaces.
- Manufactured using 30% recycled steel.



Item R36HTSBK shown with optional custom graphics. Please inquire for pricing.

Model No.	Dimensions	Capacity	Price Each	
			1-4	5 or more
R12SBK	13.5" Sq. x 32" H	12 gal.	\$205.00	\$195.00
R36HTSBK	21" Sq. x 40" H	29 gal.	590.00	565.00

Other styles and sizes available. Please inquire.

AMERICANA SERIES™

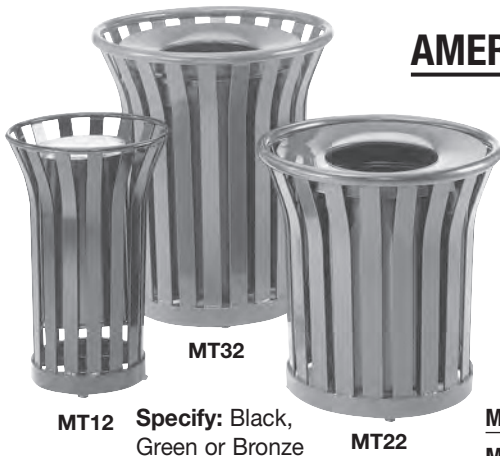

- The Americana Series is made from rugged steel with multiple layers of powder coating to ensure years of trouble free, outdoor use.
- UV stabilized to resist fading.
- Waste receptacles have removable leakproof rigid plastic liner.
- Four leg levelers permit placement on uneven surfaces.
- All models are cable secured and lift-off for easy emptying.
- Available in Black, Architectural Bronze and Green. Please specify.
- Extremely heavy, to deter theft and withstand harsh weather conditions.
- Manufactured using 30% recycled steel.

Model No.	Description	Dimensions	Capacity	Price Each	
				1-4	5 or more
MT22	Receptacle	25.5" Dia. x 25.5" H	24 gal.	\$760.00	\$735.00
MT32	Receptacle	29" Dia. x 32.5" H	36 gal.	950.00	925.00
MT12	Sand Urn	17" Dia. x 25.5" H	—	620.00	595.00

HOWARD CLASSICS™

- Fire-safe, heavy gauge, hot dipped galvanized steel construction.
- Clean, modern perforated steel design.
- Adjustable leg levelers hold receptacle off ground and provide stability.
- UV Stabilized Standard black powder coated finish with white leakproof rigid plastic liner.
- Manufactured using 30% recycled steel.



Model No.	Dimensions	Capacity	Price Each	
			1-4	5 or more
S3ETBK	18" Dia. x 35.5" H	25 gal.	\$380.00	\$355.00
S55ETBK	25" Dia. x 35.5" H	51 gal.	570.00	545.00

Available in Black Only

TERMS: 2% ten days, net 30, F.O.B. Factory. We prepay shipping and add to invoice.

INDOOR RECEPTACLES

STEEL ROUND TOP RECEPTACLES

Manufactured using 30% recycled steel.



Models **B, C** and **D** are UL Listed and FM Approved Fire Safe/Self-Extinguishing. Model **A** features hands-free foot pedal operation. All models have a self-closing reinforced push door to control odors and comply with OSHA Standards. Recessed hand grips permit easy lift-off for emptying. Non-corrosive base ring protects floors. Complete with 15 gallon galvanized steel liner. Powder coated finishes or metallic finished steel. 15" Dia. x 36" H.

Color Codes: **AL** - Almond, **BK** - Black, **CB** - Cobalt Blue, **RD** - Red, **SG** - Spruce Green, **WH** - White

Used at thousands of facilities nationwide.

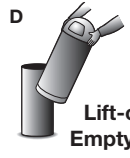

Model No.	Finish	Price Each		
		1-4	5 or more	
A	R1536STEGL	White	\$210.00	\$205.00
	R1536STEMGL (not shown)	Silver Metallic	280.00	275.00
B	R1536BSGL	Satin Brass Stainless	285.00	280.00
	R1536SSGL (not shown)	Satin Stainless	280.00	275.00
C	R1536MCGL	Mirror Chrome	370.00	360.00
D	R1536EGL	AL, BK, CB, RD, SG, WH	155.00	150.00
	R1536SMGL (not shown)	Silver Metallic	225.00	220.00

All models manufactured using 30% recycled steel.

HANDS FREE OPEN TOPS

All cans feature heavy gauge fire-safe steel construction, non-corrosive base ring to protect floors and recessed hand grips to permit easy lift-off for emptying. Open top design is perfect for high traffic areas or where a touchless environment is desired. 15 gallon capacity. Model A is UL Listed/FM Approved fire-safe and self-extinguishing.



Model No.	Dimensions	Finish	Price Each		
			1-4	5 or more	
A	R32EWH	15" Dia. x 32" H	White	\$140.00	\$130.00
	R32EBK	15" Dia. x 32" H	Black	140.00	130.00
B	R1536EOT	15" Dia. x 35.5" H	Black	145.00	135.00

Manufactured using 30% recycled steel.

WASTEMASTER RECEPTACLES

Fire-safe steel construction with a white Uni-Coat® powder coated finish. Models **A** and **B** are UL Listed and FM Approved Fire-Safe/Self-Extinguishing. Retainer bands hold poly bags securely within the leakproof rigid plastic liner. Attached hinged top with springless, self-closing dual entry door.



Model No.	Dimensions	Capacity with Liner	Price Each		
			1-4	5 or more	
A	T1414EPL	14" Sq. x 26" H	10.5 gal.	\$200.00	\$190.00
B	T1424EPL	14" Sq. x 35.5" H	16 gal.	230.00	220.00
C	T1940EPL	19" Sq. x 38" H	29 gal.	285.00	275.00

Manufactured using 30% recycled steel.

Deduct \$15 per unit if no liner required.

Stainless steel models also available. Please inquire.

Please include us on all receptacle and step-on can bids.



SINCE 1972, DISTRIBUTORS OF SPECIALTY ITEMS FOR HOSPITALS, NURSING HOMES, INSTITUTIONS

LATEST PRODUCTS CORP.

P.O. Box 190 • Syosset, New York 11791 • 1-800-288-3547 • Fax 1-516-367-4714 • email LPCORP@aol.com

WASTEBASKETS

STEEL WASTEBASKETS

UL Classified fire-safe. Puncture resistant steel construction with durable powder coated finishes. Round model has rolled wire rims, embossed panels and double-locked seams. Rectangular basket has a vinyl rim cushion and nylon buttons on legs. 1" recessed bottom on both models prevents heat transfer to floors. Manufactured using 30% recycled steel.

Model No.	Dimensions	Capacity	Price Each	
			3	6 or more
WB26	13 1/2" Dia. x 14 1/2" H	26 qt.	N/A	\$16.00
WB44	15 3/4" Dia. x 18" H	44 qt.	\$24.00	22.00
WB2029	16" Dia. x 29" H	80 qt.	40.00	38.00
WB30R	17" W x 15" H x 8" D	30 qt.	36.00	34.00
WB96R	21" W x 30" H x 11" D	96 qt.	71.00	66.00

Wastebaskets must be purchased in carton quantities.
 WB26 - 6/carton, all other models are 3/carton.
 All above models meet federal specification A-A-182 for fire hazard and flammability prevention.



Colors Available: Almond, Black, Gray

CONCEPT COLLECTION

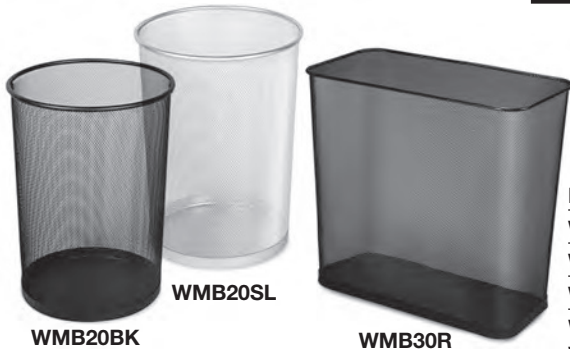

Steel mesh designs feature an attractive diamond pattern, sturdy steel construction and solid steel bases. Epoxy finish with no-sag curled rim to protect clothing and furniture. ADA Compliant. Manufactured using 30% recycled steel.

Model No.	Dimensions	Capacity	Color	Price Each	
				3	6 or more
WMB20BK	11.5" Dia. x 14" H	5 Gal.	Black	—	\$18.00
WMB20SL	11.5" Dia. x 14" H	5 Gal.	Silver	—	18.00
WMB30R	16" W x 14" H x 8.5" D	7.5 Gal.	Black	\$21.00	23.00

Wastebaskets must be purchased in carton quantities.
 WMB20 - 6/carton, WMB30R - 3/carton.

HIDE-A-BAGS

Innovative two part design conceals poly bag for a neat appearance. Unique lift-off outer sleeve and 3.5 gallon inner container is constructed of fireproof steel. Available in durable black powder coated finish with decorative stainless steel trim or all satin stainless steel. Non-corrosive vinyl base ring protects floors. 9 1/2" Dia. x 12 1/2" H.



Neatly conceals polybag

Model No.	Color	Capacity	Price Each	
			1-5	6 or more
WHB14BK	Black/Stainless	3.5 Gal.	\$45.00	\$43.00
WHB14SS	Stainless Steel	3.5 Gal.	60.00	59.00



FIVE EASY WAYS TO ORDER:

1. By Mail: P.O. Box 190 • Syosset, NY 11791
2. Toll-Free: 1-800-288-3547

3. By Fax: 1-516-367-4714
4. By email: LPCORP@aol.com

5. Through our website: www.LatestProducts.net

SMOKERS' SOLUTIONS

To keep your facility clean



ALADDIN

Factory mutual approved, oxygen restricting self-extinguishing fluted design. Fire-safe steel construction with a hammertone powder coated finish. Top is secured with a hidden chain to prevent theft and is fastened from the base with two easily operated latches for easy emptying. 4¼ gallon galvanized steel liner. 16" Dia. x 39" H. Manufactured using 30% recycled steel.

Specify Bronze or Charcoal



R1639E

Shown outdoors in use.

SMOKERS' POLE

The simple space saving solution to control smokers' waste. Unique two part ergonomic design reduces back strain and requires no tools for fast, easy maintenance. Durable, weather resistant powder coated aluminum construction. Two 3½" W x 1" H disposal openings with recessed extinguishing screen.

4" Dia. x 41" H (1¼" Dia. Base)

Specify Black or Silver Metallic



R1

Smokers' Pole

Smokers' Stations® Wall Mounted Model

Attractive, fire-safe and weather resistant means to keep smoking waste under control. Galvanized steel body with black textured powder coated finish and stainless steel door. Two disposal openings with recessed stainless steel extinguishing screen and galvanized liner provide safe disposal of cigarette butts. Mounting hardware is included. 10" W x 3" D x 12½" H. Manufactured using 30% recycled steel.



R1012E

Model No.	Description	Price Each	
		1-5	6 or more
R1012E	Wall Mounted	\$125.00	\$120.00
R1639E	Aladdin	150.00	145.00
R1	Smokers' Pole	165.00	160.00



R12SU

R18SU

R40SU

R41WU

Specify Colors:

Gray with dove gray panels

Brown with desert brown panels

Other colors available. Please inquire.

Sand Top and Weather Urn Ash/Trash Receptacles

Designed for use indoors or out. Heavy gauge, galvanized, fire-safe steel for maximum corrosion resistance. UV stabilized powder coated finish provides long lasting color protection. Natural stone panels are backed by steel, have a Class A fire rating and a 15 year limited warranty. One piece large capacity sand tops for reduced maintenance. Weather Urns feature a removable hinged top which conceals smokers' waste and shields contents from weather for neat, easy emptying. Rigid plastic liners included. Manufactured using 30% recycled steel.



Model No.	Description	Capacity	Dimensions Sq. x H.	Price Each	
				1-5	6 or more
R12SU	Sand Top/Trash	12 Gal.	13½" x 32"	\$440.00	\$430.00
R12WU	Weather Urn/Trash	12 Gal.	13½" x 35"	470.00	460.00
R41	Sand Top/Trash	2.5 Gal.	10" x 24"	250.00	240.00
R41WU	Weather Urn/Trash	2.5 Gal.	10" x 27"	320.00	310.00
R18SU	Sand Top/Trash	24 Gal.	18" x 32"	505.00	495.00
R18WU	Weather Urn/Trash	24 Gal.	18" x 35"	560.00	550.00
R40SU	Sand Top	‡	10" x 24"	190.00	180.00
R40WU	Weather Urn	‡	10" x 27"	255.00	245.00

‡ Not a trash receptacle.

Specify Gray or Brown when ordering.

Urn Sand available. Please inquire.

TERMS: 2% ten days, net 30, F.O.B. Factory. We prepay shipping and add to invoice.



SINCE 1972, DISTRIBUTORS OF SPECIALTY ITEMS FOR HOSPITALS, NURSING HOMES, INSTITUTIONS

LATEST PRODUCTS CORP.

P.O. Box 190 • Syosset, New York 11791 • 1-800-288-3547 • Fax 1-516-367-4714 • email LPCORP@aol.com

RECYCLING CONTAINERS

SILHOUETTE RECYCLING CONTAINERS

An attractive solution for recycling. Constructed of heavy gauge, fire-safe steel in your choice of Textured Black (TBK), Silver Metallic (SM) or Desert Pearl (DP) Uni-Koat powder coated finishes or satin finished Stainless Steel (SS). Round models feature lift-off tops and a 26 gallon capacity. Square models feature piano hinged tops for easy emptying and a 29 gallon capacity. Choose from three item specific openings with protective vinyl trim to meet your unique recycling needs. All models come complete with a leakproof rigid plastic liner, retainer bands to hold polybags and adjustable leg levelers to provide stability on uneven surfaces.

Square Recycling Container

Description	Model No.	Finish	Price Each	Model No.	Finish	Price Each
Can Opening	DCR24C	TBK, SM, DP	\$495.00	DCR24C	SS	\$765.00
Paper Opening	DCR24P	TBK, SM, DP	495.00	DCR24P	SS	765.00
Trash Opening	DCR24T	TBK, SM, DP	495.00	DCR24T	SS	765.00

Round Recycling Container

Can Opening	DRR24C	TBK, SM, DP	\$455.00	DRR24C	SS	\$665.00
Paper Opening	DRR24P	TBK, SM, DP	455.00	DRR24P	SS	665.00
Trash Opening	DRR24T	TBK, SM, DP	455.00	DRR24T	SS	665.00



See other Recycling Containers on pages 69 & 91

CLASSIC STAINLESS STEEL RECYCLING CONTAINERS

The classic look and contrasting appeal of durable, powder coated black tops and sleek perforated stainless steel makes recycling easy. The cable secured tops are manufactured with a customized opening, optional recycling decals clearly indicate the specific use. The rust proof stainless steel bodies are virtually weatherproof and include leakproof rigid plastic liners as well as adjustable leg levelers for stability on uneven surfaces. Optional anchoring kits available. Decals included.

Model No.	Description	Dimensions	Capacity	Price Each
S3SSPBKPL	Paper opening	18" Dia. x 35.5" H	25 gal.	\$615.00
S3SSGBKPL	Cans/glass opening	18" Dia. x 35.5" H	25 gal.	615.00
S3SSTBKPL	Trash opening	18" Dia. x 35.5" H	25 gal.	615.00
S55SSTBKPL	Trash opening	36" Dia. x 35.5" H	51 gal.	790.00



TERMS: 2% ten days, net 30, F.O.B. Factory. We prepay shipping and add to invoice.

PATIENT PRIVACY SCREENS

Durable, Attractive & Competitively Priced



69" Tall with Casters
67" Tall without Casters

STANDARD PRIVACY SCREEN WITH OR WITHOUT CASTERS

Flame-retardant vinyl panels (choice of white, blue, green or pink) wash easily. White powder coated steel frames available with 2" twin wheel casters for portability, measure 27" x 55" per panel and 17½" from floor to bottom of screen.

- | | | |
|---------------|--|------------|
| PSS-3 | Best Quality Screens – without Casters | \$110 each |
| PSS-3C | Best Quality Screens – with Casters | \$120 each |

**New Colors
Now
Available!**



TELESCOPING CURTAINS

Pull rod-hung curtains out to a full 90" from wall, push back to an out-of-the-way 51" or flat against wall. Flame-retardant, white, blue, green or pink vinyl curtain is 72" high. Kit includes wall bracket, telescoping rod, curtain and hooks.

- | | | |
|------------|--------------|-------|
| PST | Complete Kit | \$100 |
|------------|--------------|-------|

Vinyl screening meets minimum requirements of flame resistance of CA fire marshal for products identified in section 13115, CA health and safety code, and NFPA# 701.

PATIENT ROOM TABLES

ONE LOW PRICE — Order as many as you want at sharply discounted prices



**\$105 each
(delivery
additional)**

**Convenient Tilt-Top
Feature for Easy
Reading and Writing
NOW AVAILABLE
Please Inquire!**



**\$122 each
(delivery
additional)**

LOW OVERBED TABLE—ADJUSTABLE

Model # 11640 – Walnut grain laminate top
\$105.00 each.

Specifications

- | | |
|---------------------|---|
| Height Range: | 17½" - 25½", glides
19¾" - 26¾", casters |
| Table Size: | 15" x 30" |
| Table Top Material: | Laminate |
| Table Capacity: | 50 lbs. |
| Ground Clearance: | 1¾", glides
3¾", casters (2 are locking) |
| Frame: | Chrome Frame H-Base |
| Weight: | 20 lbs. |

OVERBED TABLE—ADJUSTABLE

Model # 11610 – Walnut grain laminate top
Model # 11600 – Gray laminate top
\$122.00 each.

- Laminate top with vinyl trim
- Chrome base
- Easy spring loaded height adjustment
- Four point H-base with two locking dual wheel nylon casters
- Height 28" to 43" (18" higher than low table)
- Base 15½" x 26½"
- Top 15" x 30"
- Weight: 30 lbs.
- Table capacity 50 lbs.
- Some assembly required

Please place us on your bid list for all laundry and housekeeping products.



SINCE 1972, DISTRIBUTORS OF SPECIALTY ITEMS FOR HOSPITALS, NURSING HOMES, INSTITUTIONS

LATEST PRODUCTS CORP.

P.O. Box 190 • Syosset, New York 11791 • 1-800-288-3547 • Fax 1-516-367-4714 • email LPCORP@aol.com

INDUSTRIAL LAUNDRY BASKET SCALES AND ROLLING SCALES



Easy reading dial.

4 Bushel – Stock No. **S53** (60 lb. capacity*) **\$424.00**
 6 Bushel – Stock No. **S54** (75 lb. capacity*) **\$460.00**
 *Based on typical (dry) laundry loads.

HEAVY GAUGE POLY BASKET SCALE

Removable Basket.
 Cleans easily.
 Has hand rails for moving across floors.
 35" to top of basket (39" for 6 bu.).
 35" to top of arm.
 37" wide x 20" deep.
 56 lb. weight.
 Scale head capacity is 250 lbs.
 Ships UPS knocked down.



Now also available with spring platform.

No. S70 SCALE

10 bushel. 200 lb. capacity scale in 1 lb. increments.
 Heavy all steel frame. Heavy duty nylon basket.
 4 in. ball bearing casters for easy rolling.
 Basket is 25" W x 35" L x 25" D
 Overall dimensions including top bar 30" W x 43 1/2" L x 51 1/2" H.
 Note: Scale head can only be used with basket.
 Shipping wt. 65 lbs.

#S70 \$595.00
#S70SP \$650.00 with spring platform



Just Introduced! Industrial Floor Scale

No. S1000 \$995.00

Place your laundry carts on the platform and get an accurate weight on large laundry loads. This scale is ideal for industrial laundries, hospitals, hotels and resorts. Provides consistent accuracy within 0.1% and comes equipped with an indicator for fast digital read out. There are no installation requirements and no moving parts that require maintenance or adjustment. Portable, weighs only 60 lbs. No need for ramps or recessed floors, as this unit comes with ramped ends.

- Rugged steel with tread platform 59" L x 30" W x 2.5" H.
- 1000 lbs. capacity x 1 lb. increments (also available in 2000 lb. capacity — same price).
- Adjustable foot pads allow scale to work effectively on uneven floors.
- Operates on four AAA batteries or 6V DC, 500mA adapter, both included.



Now also available with spring platform.

No. 70PL SCALE

10 bushel basket. 200 lb. capacity scale head.
 All steel frame. Heavy gauge poly basket that's easy to clean. 4 in. ball bearing casters.
 Basket is 22" W x 34" L x 25" D.
 Overall dimensions including top bar 30" W x 43 1/2" L x 51 1/2" H.
 Note: Scale head can only be used with basket.
 Shipping wt. 95 lbs.

#70PL \$730.00
#70PLSP \$790.00 with spring platform



No. S40 WIRE BASKET SCALE

For Coin-Op Applications. Basket size 26" x 18" x 10". 40 lbs. capacity in 2 ounce increments. Overall height is 20 1/4". Pound and Metric dial. Ships UPS 30 lbs.

No. S40 \$180.00



No. S11 SCALE

Capacity 50 lbs. in .05 lb. increments. Bright digital readout, low battery indicator light. Shuts off automatically after 7 minutes. Long, long battery life. Overload/underload display. ABS shatterproof housing with splash proof display. Basket measures 25 1/2" x 25 1/2" x 11 1/2". Overall height is 20". Ships UPS 30 lbs.

No. S11 \$355.00

SCALE CART — 3" SWIVEL CASTERS

Easy to use, easy to roll, accurate laundry scale cart.
 Removable one piece gray polyethylene tub.
 Sturdy chrome steel frame.
 3" all swivel casters.
 Heavy duty industrial scale.
 4 Bushel - 33" x 19" x 29" for up to 250 lb. loads.
 6 Bushel - 33" x 23" x 33" for up to 250 lb. loads.
 Ships UPS.

#MSC411 4 bu 33" x 19" x 29" \$430.00
#MSC461 6 bu 33" x 23" x 33" \$465.00



Ask us about our other scales including bariatric scales, chair scales, in-bed scales, patient lift scales, and wheelchair scales. All available for quick shipping. Please inquire for details.

ROLLING GARMENT AND COAT RACKS

HEAVY DUTY CONSTRUCTION - DURABLE EASY-ROLLING BASE

Base is painted - Uprights and Hanger 14 gauge plated steel with 4" ball bearing swivel wheel casters with cushion tread.
Racks are shipped knocked down. Easily assembled.

IMPORTANT: All units can be shipped by UPS except 1335-72 and 1333-72 which must be shipped common carrier.

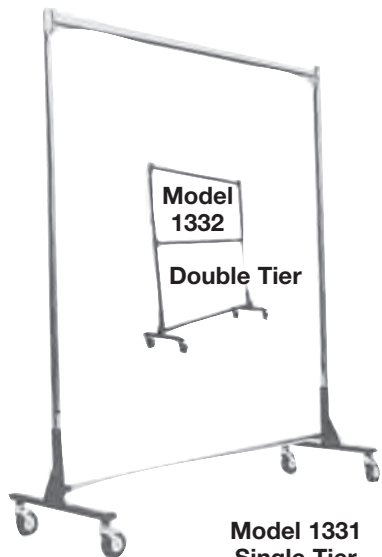

Model 1331
Single Tier



Model 1333



Bottom Shelf with
breathing holes



Solid Bottom Shelf

See our website
for new nestable
garment racks!

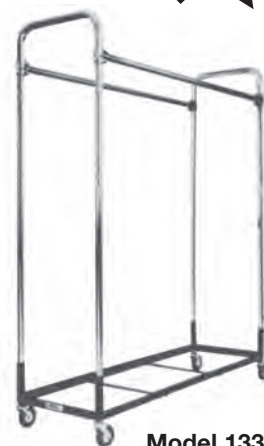

Model 1335

ALL UNITS SUPPLIED WITH 4" SWIVEL CASTERS

Garment Rack, Heavy Duty, Adjustable Height, Single Tier

No.	Width	Length	Maximum Height	Weight	Price
1331-36	20"	36"	72"	30 lbs.	\$140.00
1331-48	20"	48"	72"	32 lbs.	150.00
1331-60	20"	60"	72"	34 lbs.	155.00
1331-72	20"	72"	72"	36 lbs.	170.00

For 5" Casters add \$30.00
For 5" Rubber Corner Bumpers add \$30.00

Garment Rack, Heavy Duty, Adjustable Height, Double Tier

No.	Width	Length	Maximum Height	Weight	Price
1332-36	20"	36"	78"	34 lbs.	\$165.00
1332-48	20"	48"	78"	36 lbs.	175.00
1332-60	20"	60"	78"	38 lbs.	185.00
1332-72	20"	72"	78"	40 lbs.	205.00

For 5" Casters add \$30.00
For 5" Rubber Corner Bumpers add \$30.00

Garment Rack, Heavy Duty, Single Top Bar

No.	Width	Length	Height	Weight	Price	With Bottom Shelf**
1333-48	20"	48"	72"	68 lbs.	\$290.00	\$370.00
1333-60	20"	60"	72"	72 lbs.	295.00	395.00
1333-72	20"	72"	72"	76 lbs.	340.00	445.00

For 5" Casters add \$70.00
For 5" Rubber Corner Bumpers add \$75.00

Garment Rack, Heavy Duty, Double Top Bar

No.	Width	Length	Height	Weight	Price	With Bottom Shelf**
1335-48	28"	48"	72"	70 lbs.	\$315.00	\$470.00
1335-60	28"	60"	72"	74 lbs.	360.00	495.00
1335-72	28"	72"	72"	78 lbs.	420.00	515.00

For 5" Casters add \$70.00
For 5" Rubber Corner Bumpers add \$75.00

**Shelf: Specify SM for Solid Metal or Specify EM for Shelf with Breathing Holes

Used in hospitals to move garments such as lab coats, and
in nursing homes for admission or discharge of patients.



SINCE 1972, DISTRIBUTORS OF SPECIALTY ITEMS FOR HOSPITALS, NURSING HOMES, INSTITUTIONS

LATEST PRODUCTS CORP.

P.O. Box 190 • Syosset, New York 11791 • 1-800-288-3547 • Fax 1-516-367-4714 • email LPCORP@aol.com

SAFETY PRODUCTS

At Low, Low Discounted Prices

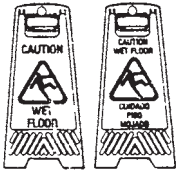

WET FLOOR SIGNS

Description	Item #	Color
Caution – Wet Floor/Cuidado – Piso Mojado	9152W	Yellow
Caution – Wet Floor (English only)	9152E	Yellow

Packed 6 per case (no broken cases) – 11" W x 24" H x 1" Thick.
Buy 3 or more cases, take an additional 5% off.

ONE LOW PRICE –
Order as many as you
want **ONLY \$87/Case**
(\$14.50/each)
Packed 6 per case

FLOOR SIGNS WITH SIDE BAR – 25" High

Description	Item #	Color
Caution – Wet Floor/Cuidado – Piso Mojado	24106	Yellow
No Entry/Restroom Closed	24109	Yellow

Packed 6 per case (no broken cases)

Buy 3 or more cases, take an additional 5% off.



Side Bar

\$129/Case (\$21.50/each)
Packed 6 per case

Top Flashing Light



4 SIDED FLOOR SIGNS Available with or without Top Flashing Light

Description	25" H	36" H	Color
Caution	—	23887	Yellow
Caution – Wet Floor	23812	23870	Yellow
Caution – Wet Floor/Cuidado – Piso Mojado	23816	23879	Yellow
Caution – Wet Floor/Cuidado – Piso Mojado	—	24236	Fluorescent Green

Packed 5 per case (no broken cases). Top flashing light is available as an option for \$28 per sign and requires two AA batteries (not included).

Buy 3 or more cases, take an additional 5% off.

ONE LOW PRICE –
25" **ONLY \$145/case of 5**
36" **ONLY \$198/case of 5**
Above prices are for sign only.
Optional flashing light
additional at \$28 each.

SAFETY POLES

Prevents Room Entry During Cleanup and Maintenance

ONE LOW PRICE –
Order as many as you
want **ONLY \$162/Case**
(\$27/each)

Description	Item#	Color
Closed for Cleaning	9175	Fluorescent Green
Closed for Maintenance	9177	Fluorescent Green

Packed 6 per case (no broken cases).

Extends 30" to 44" so as to fit most standard doors.

Buy 3 or more cases, take an additional 5% off.



We also offer 3-sided safety signs, wet floor cones, safety cones and barrier tape.

Buy 2 or more and take 5% off!

STAINLESS STEEL SHOWER CHAIRS/COMMODOES

Will Not Rust!



C-SS-1200 Palladium Series \$1,065.00

The Palladium Series Stainless Steel Chair/Commode has quickly become our most popular model due to its unique dual dropping side arms. Designed for bariatric patients up to 1000 pounds and under. It can be used as a shower chair, bedside commode and an over-the-toilet commode. Comes standard with 4" Total Lock casters which when locked, provide a solid platform for the patient to get on and off with ease. Easy to clean. Available in white or black.

Collection bucket included.

Dimensions

- 40" High x 22" Wide x 20" Deep
- 22" clearance between arm rests
- 1000 lb. capacity



C-GS-700 Gold Series \$1,025.00

The Gold Series Stainless Steel Chair/Commode was designed for bariatric patients 700 pounds and under. It comes standard with 4" Total Lock casters which when locked, provide a solid platform for the patient to get on and off with ease. The stainless steel construction can meet any service condition and a custom trainable option is available.

Collection bucket included.

Dimensions

- 36" High x 32" Wide x 21" Deep
- 29" clearance between arm rests
- 700 lb. capacity



Largest Shower Chair/Commode on the market today!

C-PS-1000 Platinum Series \$1,395.00

The Platinum Series Stainless Steel Chair/Commode was designed for bariatric patients 1000 pounds and under. It comes standard with 4" Total Lock casters which when locked, provide a solid platform for the patient to get on and off with ease. The stainless steel construction can meet any service condition and a custom trainable option is available.

Collection bucket included. (not shown)

Dimensions

- 36" High x 39" Wide x 21" Deep
- 36" clearance between arm rests
- 1000 lb. capacity

See Pages 84 and 85 for More Shower Chairs and Commodes →

FIVE EASY WAYS TO ORDER:

1. By Mail: P.O. Box 190 • Syosset, NY 11791
2. Toll-Free: 1-800-288-3547

3. By Fax: 1-516-367-4714
4. By email: LPCORP@aol.com

5. Through our website: www.LatestProducts.net



SINCE 1972, DISTRIBUTORS OF SPECIALTY ITEMS FOR HOSPITALS, NURSING HOMES, INSTITUTIONS

LATEST PRODUCTS CORP.

P.O. Box 190 • Syosset, New York 11791 • 1-800-288-3547 • Fax 1-516-367-4714 • email LPCORP@aol.com

PVC SHOWER CHAIRS/COMMODOES

Fully Customizable to Meet Your Facility's Specific Needs!



Buy 2 or more and take 5% off!



C-SSC700 includes collection bucket **\$395.00**

- 38.5" H x 21.5" W x 20" D
- 17" clearance between arms.
- 300 lb. capacity.
- 17" clearance.
- Can be used as shower chair or commode chair.
- Deluxe open-front soft seat with pail.
- Deluxe matching soft backrest and waterproof seat.
- No-rust twin-wheel locking casters are standard.
- Available in (G) Gray, (N) Navy or (L) Laguna Green.

C-SC717 collection bucket not included **\$309.00**

- 38" H x 21" W x 20" D
- 18" clearance between arms.
- 300 lb. capacity.
- 17" clearance.
- Can be used as shower chair or commode chair.
- Open-front no slip, soft seat for easy washing.
- Backrest is designed for real comfort and is available in multiple colors.
- No-rust twin-wheel locking casters are standard.
- Available in (G) Gray, (N) Navy or (L) Laguna Green.

C-SCC767 includes collection bucket **\$479.00**

- 41" H x 21" W x 20" D
- 18" clearance between arms.
- 300 lb. capacity.
- 20" clearance.
- Can be used as shower chair or commode chair.
- Left drop arm.
- Deluxe soft seat (open front available with pail).
- Mesh (Standard) or Deluxe backrest available.
- Slideout footrest with anti-tip design.
- No-rust twin-wheel locking casters are standard.
- Available in (G) Gray, (N) Navy or (L) Laguna Green.



C-SC9111 includes slant seat feature and collection bucket **\$225.00**

- 38" H x 21" W x 20" D
- 18" clearance between arms.
- 300 lb. capacity.
- 17" clearance.
- Can be used as shower chair or commode chair.
- No-rust twin-wheel locking casters are standard.
- Available in (G) Gray, (N) Navy or (L) Laguna Green.

Slant Seat Feature:

This feature, available on all chairs, helps hold patients in position. The seat is lower in the back to prevent sliding forward. With this feature, many patients will stay in position without the use of restraints.



Our most popular model with VA Hospitals

C-SCC255 **\$412.00**

- 41" H x 21" W x 20" D
- 18" clearance between arms.
- 300 lb. capacity.
- **Made to accommodate bedpans.**
- Available in (G) Gray, (N) Navy or (L) Laguna Green.

FIVE EASY WAYS TO ORDER:

1. **By Mail:** P.O. Box 190 • Syosset, NY 11791
2. **Toll-Free:** 1-800-288-3547

3. **By Fax:** 1-516-367-4714
4. **By email:** LPCORP@aol.com

5. **Through our website:** www.LatestProducts.net

Used by
Nursing Homes
and Assisted
Living Facilities

PVC SHOWER CHAIRS/COMMODOES EXTRA CAPACITY & BARIATRIC MODELS



C-SCC9250-OS \$305.00

- 40" H x 25" W x 25" D
- 22" clearance between arms.
- 350 lb. capacity.
- 19" clearance.
- Can be used as shower chair or commode chair.
- High quality PVC construction.
- 12 quart removable pail slides out from the side.
- Easy to clean with anti-tip design.
- 4" locking casters. 5" & 6" Deluxe casters available.
- Mesh backrest available in multiple colors*.



C-BS-C660 \$970.00

- 39.5" H x 34" W x 27.5" D
- 28" clearance between arms.
- 700 lb. capacity.
- Can be used as shower chair or commode chair.
- Seat height 21".
- High density polyethylene flat seat.
- Elongated seat hole and pail.
- 6 heavy duty 5" casters (4 locking).
- Slideout footrests standard.
- Convenient push handles.
- Heavy-duty 1-1/2" pipe.
- Mesh backrest available in multiple colors*.



C-BS-C880 \$1,295.00

- 40" H x 36" W x 31" D
- 30" clearance between arms.
- 900 lb. capacity.
- Can be used as shower chair or commode chair.
- Seat height 21".
- High density polyethylene flat seat.
- Large seat hole and pail.
- 6 heavy duty 5" casters (4 locking).
- Slideout footrests standard.
- Convenient push handles.
- Heavy-duty 1-1/2" pipe.
- Mesh backrest available in multiple colors*.

*Colors available: White, Navy Blue, Maroon, Silver, Forest Green, Teal, Plum.

Options for All PVC Shower Chairs/Commodes



Deluxe Soft Seat



Open Front Deluxe Seat



Deluxe Split Seat



Privacy Skirt



Lap Bar



Seat Belt

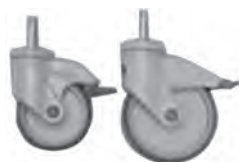

Multiple Caster Sizes



Slideout Footrest



Drop Arm

Please ask us about the other PVC products we offer, including patient gurneys and transport boards, restraint-free low beds, pillow carts, and more!



SINCE 1972, DISTRIBUTORS OF SPECIALTY ITEMS FOR HOSPITALS, NURSING HOMES, INSTITUTIONS

LATEST PRODUCTS CORP.

P.O. Box 190 • Syosset, New York 11791 • 1-800-288-3547 • Fax 1-516-367-4714 • email LPCORP@aol.com

STANDARD IV STAND

Buy 3 or more and take 10% off!

Model 1000D Standard Stainless Steel IV Stand

\$290.00 with 3" Deluxe Casters.

We constructed our stainless steel pole with your heaviest duties in mind. They are stackable for tight storage areas and trainable for ease of multiple transport.

The stand's self-flushing design drains fluids, making it perfect for automated cleaning and decontaminating.

An MRI-compatible version is also available. Contact us for more details.

CASTER SIZES: 2-5" casters are available, ranging from standard to full-locking, maintenance-free deluxe options.

WEIGHT: 25-100 lb. weights are available to give additional stability.

ACCESSORIES: Available with up to twelve Bag Hooks. Also Patient Rings, Sharps Holders, Equipment Baskets, Shelves, Locking Drawers, Power Strips, O₂ Holders, and Stenciling are available.

We're proud to say this is the finest IV Pole the market has to offer!

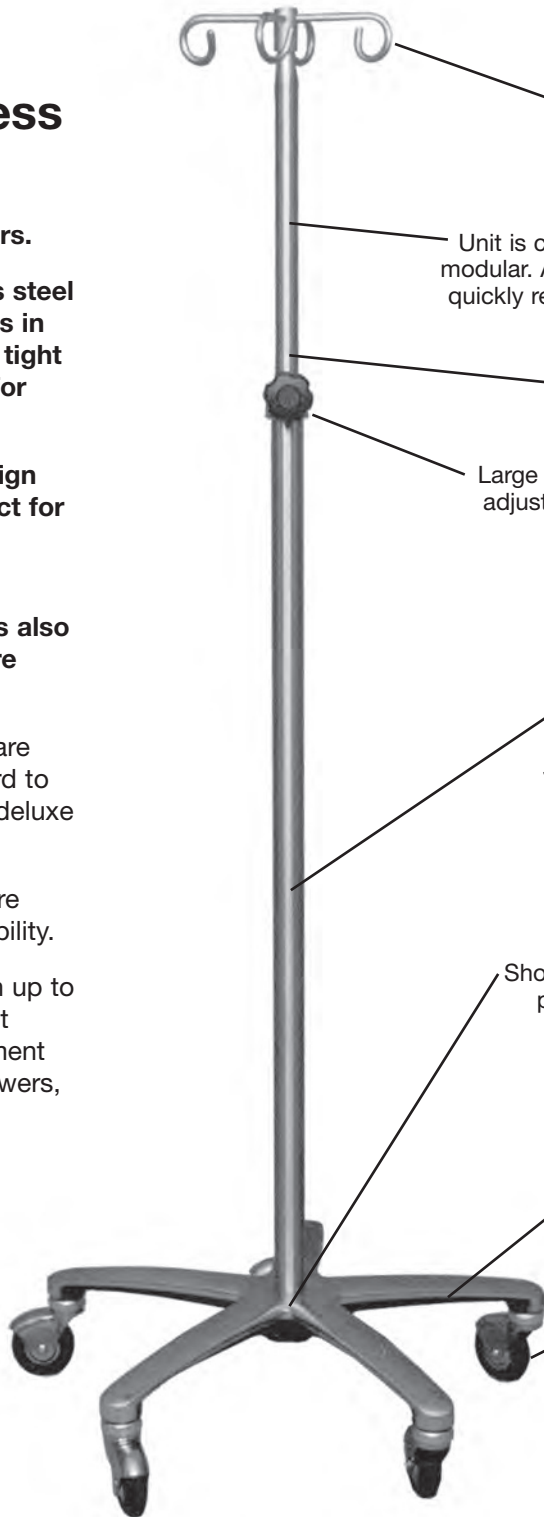

Equipped with the strongest bag hooks in the industry.

Unit is completely modular. All parts are quickly replaceable.

Can be raised up to 92 inches tall.

Large knurled knob is easy to adjust, even with wet hands.

Stand is made from the highest quality **stainless steel** and is self-draining.

Shock-absorbing feature allows pole to be lowered safely.

All surfaces are curved to shed liquids and ease cleaning.

Multiple grades of casters are available, including maintenance-free and full locking designs.

We are so confident these are the finest IV Poles on the market today, that we will send you one for a 30 day no obligation evaluation. If you are not satisfied, you can return the IV Pole in its original carton and we will invoice you for the original shipping costs only.

SURGICAL/OPERATING ROOM IV STAND

Model 1000D-OR Surgical O.R. IV Stainless Steel Stand

\$445.00 with 3" Deluxe Casters and 25 lb. weight included.

We created this Surgical O.R. Stand to surpass the stringent standards that the operating room demands.

Its superior design provides the strength to support slung arms or legs in orthopedic procedures.

CASTER SIZES: 2-5" casters are available, ranging from standard to full-locking, maintenance-free deluxe options.

WEIGHT: 25-100 lb. weights are available to give additional stability.

ACCESSORIES: Available with up to twelve Bag Hooks. Also Patient Rings, Sharps Holders, Equipment Baskets, Shelves, Locking Drawers, Power Strips, O₂ Holders, and Stenciling are available.

This stand is stronger than any unit you've ever seen. We're proud to say this is the best stand the market has to offer!

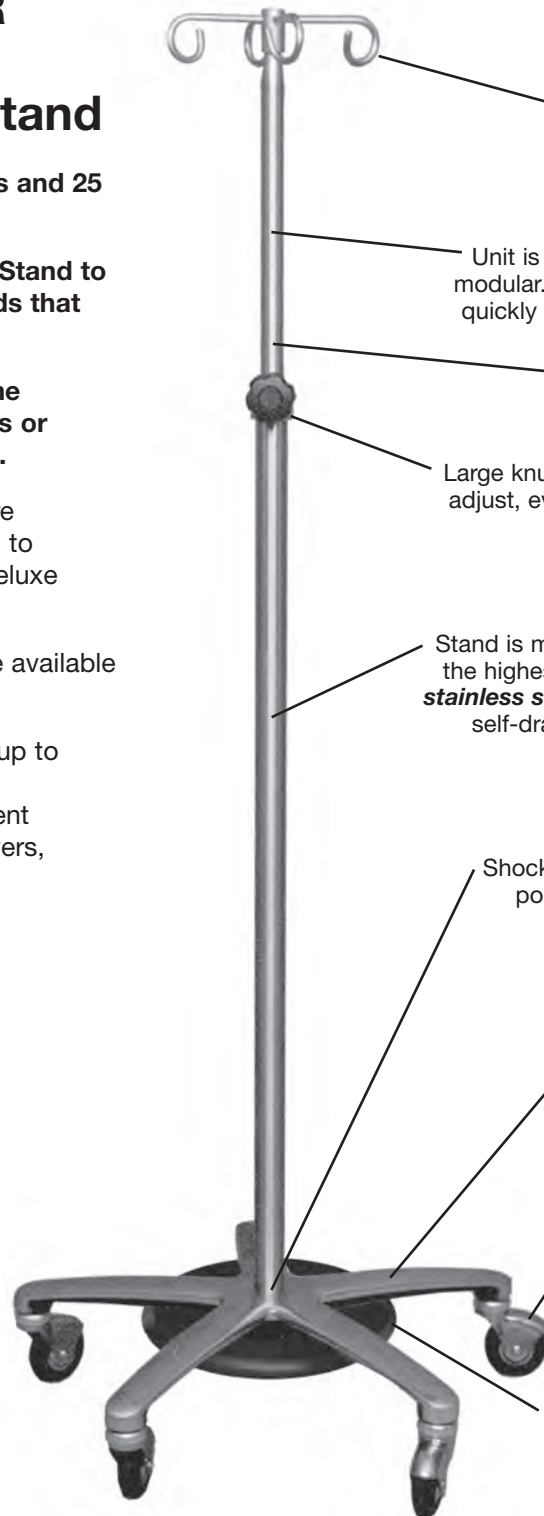

Buy 3 or more and take 10% off!

Equipped with 4 bag hooks, and is available with up to 12.

Unit is completely modular. All parts are quickly replaceable.

Can be raised up to 92 inches tall.

Large knurled knob is easy to adjust, even with wet hands.

Stand is made from the highest quality **stainless steel** and is self-draining.

Shock-absorbing feature allows pole to be lowered safely.

All surfaces are curved to shed liquids and ease cleaning.

Multiple grades of casters are available, including maintenance-free and full locking designs.

Designed to hold 25-100 pounds of additional weight.

We are so confident these are the finest IV Poles on the market today, that we will send you one for a 30 day no obligation evaluation. If you are not satisfied, you can return the IV Pole in its original carton and we will invoice you for the original shipping costs only.



SINCE 1972, DISTRIBUTORS OF SPECIALTY ITEMS FOR HOSPITALS, NURSING HOMES, INSTITUTIONS

LATEST PRODUCTS CORP.

P.O. Box 190 • Syosset, New York 11791 • 1-800-288-3547 • Fax 1-516-367-4714 • email LPCORP@aol.com

2000C IV STAND WITH POWERSTRIP

Model 2000C Custom O.R. IV Stainless Steel Stand

Buy 3 or more and take 10% off!

\$499.00 with 3" Deluxe Casters and 25 lb. weight included.

We created this Custom Stainless Steel Stand to surpass the stringent standards that today's hospitals demand.

Its superior design provides the strength and resilience that – even when loaded up with multiple pumps, bags and accessories – provides a stable platform that is effortless to work with.

CASTER SIZES: 2-5" casters are available, ranging from standard to full-locking, maintenance-free deluxe options.

WEIGHT: 25-100 lb. weights are available to give additional stability.

OPTIONAL ACCESSORIES: Patient Rings, Sharps Holders, Equipment Baskets, Shelves, Locking Drawers, O₂ Holders, and Identification (color-coded illumination) and Identification Stenciling are available.

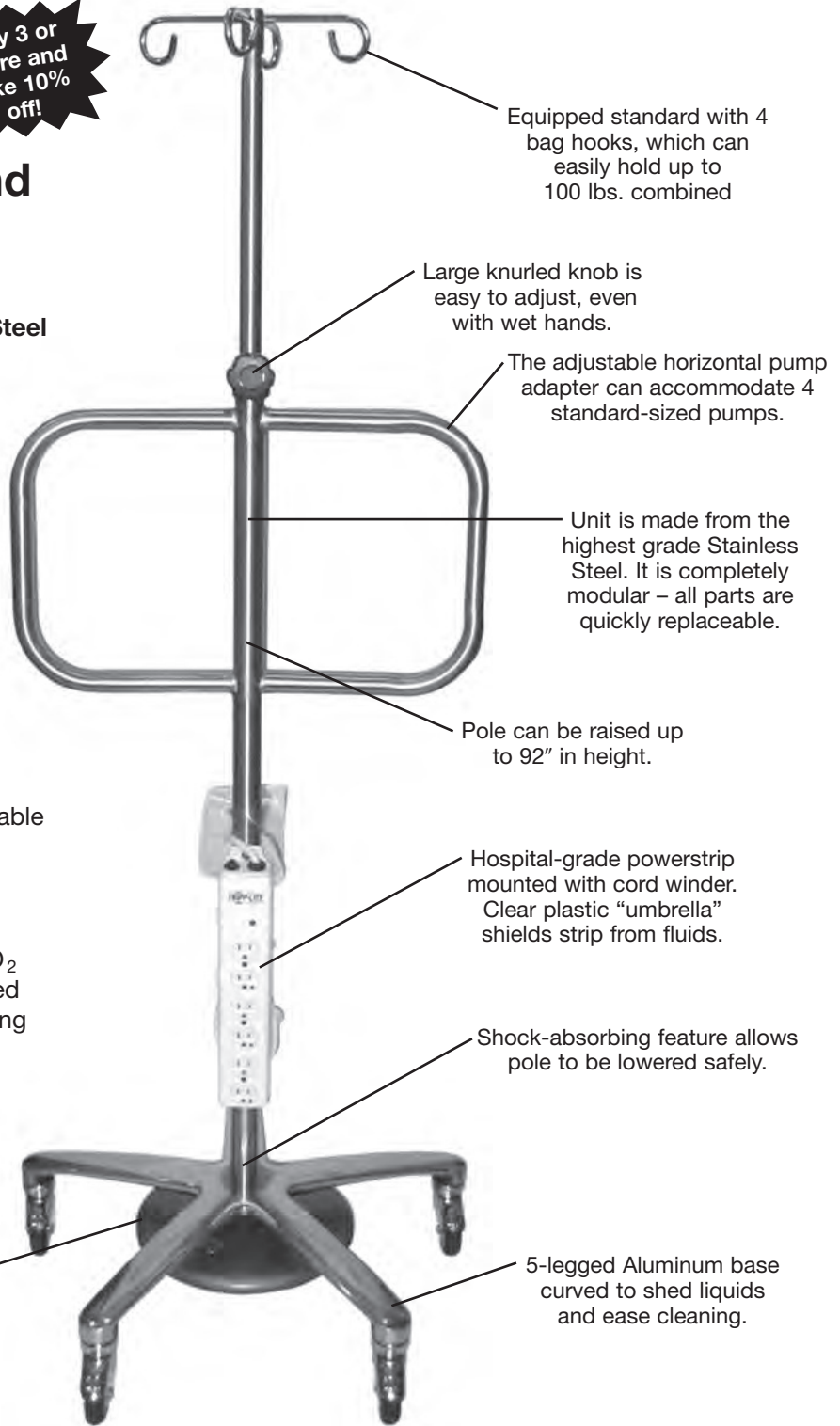

Equipped standard with 4 bag hooks, which can easily hold up to 100 lbs. combined

Large knurled knob is easy to adjust, even with wet hands.

The adjustable horizontal pump adapter can accommodate 4 standard-sized pumps.

Unit is made from the highest grade Stainless Steel. It is completely modular – all parts are quickly replaceable.

Pole can be raised up to 92" in height.

Hospital-grade powerstrip mounted with cord winder. Clear plastic "umbrella" shields strip from fluids.

Shock-absorbing feature allows pole to be lowered safely.

A 25-100 lb. weight mounted below the base provides additional stability for multiple pumps.

5-legged Aluminum base curved to shed liquids and ease cleaning.

We are so confident these are the finest IV Poles on the market today, that we will send you one for a 30 day no obligation evaluation. If you are not satisfied, you can return the IV Pole in its original carton and we will invoice you for the original shipping costs only.

STAINLESS STEEL CLOSED CASE CARTS

Case Carts

The functional design of our Case Carts maximizes usable inside storage space and provides superior maneuverability. Carts can be used wherever contents must be protected from an “unclean” environment, including free-standing ambulatory care centers, surgi-centers and hospital based/outpatient surgeries. Shelves sold separately (below).

CASE-24L6S — Cart is space efficient and can be used for minor surgery, labor and delivery and outpatient procedures. Low capacity with functional work surface.

CASE-24H6S — High profile cart saves floor space and minimizes bending. Medium capacity, small footprint.

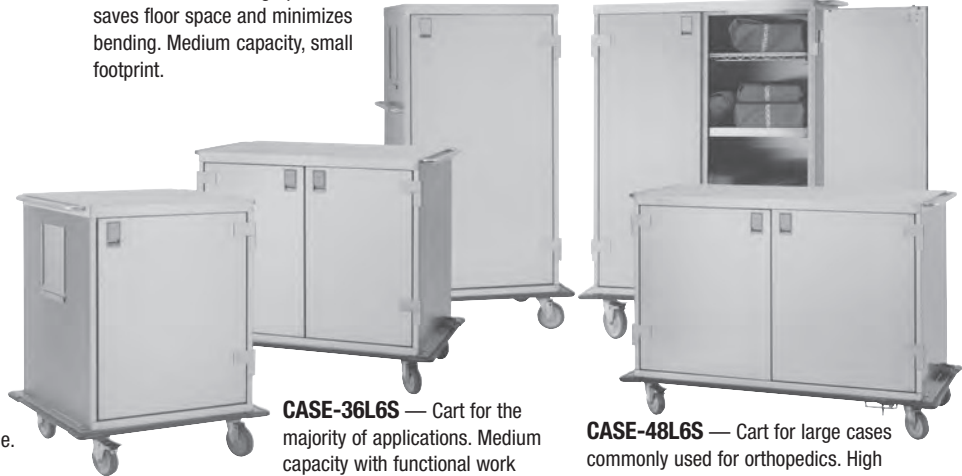

CASE-36L6S — Cart for the majority of applications. Medium capacity with functional work surface.

CASE-48L6S — Cart for large cases commonly used for orthopedics. High capacity with functional work surface.

CASE-36H6S — Cart for large or multiple cases, commonly used for orthopedics. High capacity, moderate footprint. Shown with optional shelves.

Width		Height		Approx. Pkd. Wt. (lbs.)	Cat. No. with 6" Stainless Casters	Price Each	Cat. No. with Passive Lock	Price Each
Overall (inches)	Cabinet (inches)	Overall (inches)	Cabinet (inches)					
33	28	40	31	115	CASE-24L6S*	\$2,070.00	CASE-24L6SP*	\$2,125.00
45	40	40	31	186	CASE-36L6S*	2,685.00	CASE-36L6SP*	2,745.00
57	52	40	31	212	CASE-48L6S*	2,945.00	CASE-48L6SP*	3,000.00
33	28	57	42	162	CASE-24H6S*	2,415.00	CASE-24H6SP*	2,470.00
45	40	57	42	262	CASE-36H6S*	3,025.00	CASE-36H6SP*	3,080.00

All units are 28 1/2" deep overall. Cabinet depth is 25 1/8".
*Order shelves separately.

Optional Shelves (Wire Pullout, Wire Pullout with Rollers, Solid)

Cart	Shelf Size (inches)	Approx. Pkd. Wt. (with 2 brackets)			Approx. Pkd. Wt. (with 2 brackets)			Approx. Pkd. Wt. (with 2 brackets)		
		(lbs.)	Cat. No. Wire Shelf	Price Each	(lbs.)	Cat. No. Roller Shelf	Price Each	(lbs.)	Cat. No. Solid Shelf	Price Each
CASE-24	24 x 24	9	CASE-24W	\$195.00	12	CASE-24R	\$225.00	15	CASE-24S	\$205.00
CASE-36	24 x 36	13	CASE-36W	230.00	16	CASE-36R	265.00	19	CASE-36S	245.00
CASE-48	24 x 48	19	CASE-48W	265.00	21	CASE-48R	295.00	25	CASE-48S	276.00

Each shelf includes two attachment brackets.
Shelf weight capacity is 150 lbs. evenly distributed.



Optional wire roller shelf, pulls out halfway, easily and quietly, even at the bottom level where accessibility is vital.



Ergonomic full length handles (on both sides of the low-profile carts) allow for convenience in pushing or pulling from either end and provide better cart control.



Detachable brackets remove for faster and easier cleaning and drying. Brackets, which hold shelves, attach and detach quickly from “keyhole” slots for easy shelf adjustability at 2" increments.



Double panel door provides optimum strength. Recessed latch eliminates a catch point. Two-door models have a center flange to stop splashes from entering cart.



Stainless Steel Caster Specially designed stainless steel casters provide easy maneuverability even through frequent cart washings. It features long wearing, shock absorbing, polyurethane tread.

Note: Two swivel casters and two swivel casters with brake are standard on the 24" and 36" length models. The 48" model comes standard with one brake, one swivel-lock and two swivel casters. Brakes and swivel locks are conveniently located to be activated.

Please share our catalog with other departments throughout your facility who may be interested in our products. We would be happy to send another catalog upon request.



SINCE 1972, DISTRIBUTORS OF SPECIALTY ITEMS FOR HOSPITALS, NURSING HOMES, INSTITUTIONS

LATEST PRODUCTS CORP.

P.O. Box 190 • Syosset, New York 11791 • 1-800-288-3547 • Fax 1-516-367-4714 • email LPCORP@aol.com

CHROME SUTURE CARTS AND STERILE WRAP RACK CARTS

Buy 2 or more and take 5% off!

Suture Carts

Slanted shelves present contents for instant identification and access. Allows logical organization, eliminates confusion, makes ordering easy.

Width/Length (inches)	Height (inches)	Description	Approx. Pkd. Wt. (lbs.)	Catalog Number	Price Each
18 x 24	60	One Flat and Four Slanted Shelves	105	DC15EC	\$635.00
18 x 24	60	Five Slanted Shelves	113	DC16EC	650.00
18 x 36	60	One Flat and Four Slanted Shelves	98	DC35EC	660.00
18 x 36	70	Five Slanted Shelves	100	DC36EC	700.00
18 x 48	60	One Flat and Four Slanted Shelves	115	DC55EC	705.00
18 x 48	70	Five Slanted Shelves	118	DC56EC	735.00

Note: All Suture Carts include package of 12 retainers.

Note: Shelves slant at a 45° angle or 9° from front to back.



DC56EC



DC16EC

Additional Wire Shelves

Width/Length (inches)	Approx. Pkd. Wt. (lbs.)	Catalog Number	Price Each
18 x 24	10.5	1824DNC	\$65.00
18 x 36	14.5	1836DNC	75.00
18 x 48	18.5	1848DNC	80.00

Additional Retainers

Length (inches)	Height (inches)	Approx. Pkd. Wt. per 12 pieces (lbs.)	Catalog Number	Price Each
17	4	1	DCR17C	\$12.00

High-Profile Sterile Wrap Rack

Designed to provide a safe, convenient area to hold wrap. One sheet or several sheets can be removed quickly and neatly. Bottom shelf may be used to hold extra wrap or less frequently used sizes.

Shelf Width (inches)	Shelf Length (inches)	Overall Height (inches)	Bottom Shelf Material	Frame Material	Post Material	Approx. Pkd. Wt. (lbs.)	Catalog Number	Price Each
24	48	68	Chrome	Chrome	Chrome	83.1	SWR556DC	\$740.00
24	60	68	Chrome	Chrome	Chrome	94.3	SWR566DC	795.00

Note: Special length posts are available. Cart Covers available. See pages 10-11.



SWR566DC

Additional Support Bars (For High-Profile Rack)

Length (inches)	Catalog Number	Price Each
48	SWRB5S	\$45.00
60	SWRB6S	50.00

We gladly accept Mastercard, Visa and American Express.

INDOOR METAL RECYCLING CONTAINERS

Four: Color Choices
Lid Options
Convenient Sizes

New Color and Size Options Added!

Buy 4 or more and take 5% off!

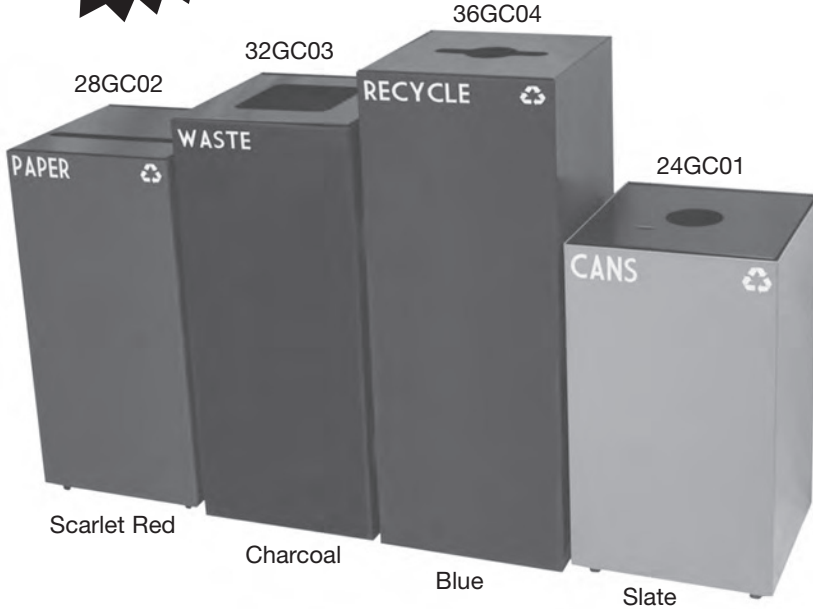

GeoCubes Lid Options



01-Round Opening



02-Slot Opening



03-Square Opening



04-Combo Opening



New and improved bag holders to make servicing easier.

GeoCube Recycling Containers

Makes separating waste from recyclables easy

- Space efficient receptacle for recycling
- Mix and match GeoCubes for unique combinations
- Compact and fire-safe steel construction
- Attractive, functional choice for hospitals, nursing homes, correctional facilities, or as part of any organization's recycling program
- Each top comes with one each of the following decals:
 - ◊ Combo opening: "Recycle" (two each)
 - ◊ Round Opening: "Cans" and "Bottles"
 - ◊ Slot Opening: "Paper" and "Recycle"
 - ◊ Square Opening: "Waste" and "Recycle"
 - ◊ Optional "Plastic" and "Glass" available on request
- Available in four colors: Blue, Charcoal, Scarlet Red and Slate

New Features

- 36 gallon size
- Blue color available in all sizes
- Combination top option
- Bag holder
- Decal style

Item Number	Description	Capacity	Dimensions	Weight	Lid Options	Colors	Price
24GC	GeoCube recycling unit	24 gal.	15" x 15" x 24"	24 lbs.	01, 02, 03, 04	SC, CB, SL, BL	\$165
28GC	GeoCube recycling unit	28 gal.	15" x 15" x 28"	27 lbs.	01, 02, 03, 04	SC, CB, SL, BL	\$175
32GC	GeoCube recycling unit	32 gal.	15" x 15" x 32"	31 lbs.	01, 02, 03, 04	SC, CB, SL, BL	\$190
36GC	GeoCube recycling unit	36 gal.	15" x 15" x 36"	34 lbs.	01, 02, 03, 04	SC, CB, SL, BL	\$205

Colors: SC-Scarlet Red, CB-Charcoal, SL-Slate, BL-Blue

TERMS: 2% ten days, net 30, F.O.B. Factory. We prepay shipping and add to invoice.



SINCE 1972, DISTRIBUTORS OF SPECIALTY ITEMS FOR HOSPITALS, NURSING HOMES, INSTITUTIONS

LATEST PRODUCTS CORP.

P.O. Box 190 • Syosset, New York 11791 • 1-800-288-3547 • Fax 1-516-367-4714 • email LPCORP@aol.com

SECURE DOCUMENT CONTAINERS

Latest Products Corporation is pleased to announce our new **SECURE DOCUMENT CONTAINERS** are now in stock and available for shipping! If your organization is required to comply with the **Health Insurance Portability and Accountability Act (HIPAA)** or the **Fair and Accurate Credit Transactions Act (FACTA)**, our secure document containers are just what you need! All models are fire-safe and designed to keep documents completely confidential until disposal.

Secure Document Containers are Ideal for Use In:

Hospitals • Nursing Homes • Assisted Living Facilities • Correctional Facilities • Universities
Government Facilities • VA Hospitals • General Industry

WHEREVER SECURITY OF CONFIDENTIAL DOCUMENTS IS CRITICAL

We are offering two series of containers:

Our PLATINUM series:

- 36 gallon capacity with vinyl drawstring bag as standard equipment
- Includes lock and 2 keys
- Flat top with front-door opening
- Made of fire-safe metal and available in 2 colors (light gray and charcoal)
- 18" × 20" × 31", weighs 35 lbs.

Our MODIFIED series:

- Available in three capacities—24, 28 or 32 gallon
- Includes lock and 2 keys
- Top-opening
- Made of fire safe metal and available in 2 colors (light gray and charcoal)
- 15" × 15" with height of 24" for 24 gallon, 28" for 28 gallon or 32" for 32 gallon

Buy 3 or more and take 5% off!

36PSS



Model #36PSS
PLATINUM SERIES \$229 each

28MSR



24MSR



32MSR



MODIFIED SERIES

- | | |
|-----------|---------------------------|
| 24 gallon | \$170 each (Model #24MSR) |
| 28 gallon | \$190 each (Model #28MSR) |
| 32 gallon | \$198 each (Model #32MSR) |



Don't risk confidential information ending up in the wrong hands!

ISOLATION CARTS & ACCESSORIES

**All PVC Carts
Fully Customizable
Can be Made
MRI Compatible
Manufactured in USA**

3-DRAWER PVC ISOLATION CART ST-33

This PVC cart is an economical way to store all of your Isolation Unit needs. Each drawer measures 7"H x 19"W x 14"D. Functional top work surface measures 26"L x 15"D. Floating backboard can accommodate various accessories (not included). Sides and back of cart encased with yellow woven mesh material to designate isolation needs. Comes with 4" casters standard. Dimensions: 45"H x 26"W x 15"D
Price: \$329



ISOLATION GOWN STORAGE CART C-ISO-4001

This PVC cart is perfect for under counter use or tight spaces. It is available with or without lid. Comes with 3" deluxe "silent" carpet master casters. Yellow woven mesh standard—other fabrics/colors available. Front screen printing available to meet your specific needs. Holds approximately 75 gowns. Dimensions: 32"H x 21"W x 18.5"D
Price: Without Lid \$209
With Lid (model C-ISO-4001L) \$229



ISOLATION GOWN COLLECTION CART C-LH21D-YELLOW-ISO

Our Isolation Gown Collection Cart comes standard with a yellow woven mesh zipper-front bag. It is designed to work with 39 gallon plastic or reusable leakproof bags. Zipper-front closure allows for easy release and removal of bag. Lid and foot pedals are standard. Comes with 3" locking deluxe TENTE casters. Dimensions: 37"H x 18"W x 18"D
Price: \$210



GLOVEBOX HOLDERS

Design your own Single, Double, or Triple glove box holder. Units can be mounted to walls or to carts (hardware included). Made of VIVAK transparent polycarbonate—offers superior strength and durability over acrylic!
C-GB-01 Single Glove Box Holder \$40
C-GB-02 Double Glove Box Holder \$62
C-GB-03 Triple Glove Box Holder \$65

Additional Steel & Aluminum Carts Available Please inquire

3-DRAWER ISOLATION CART C-3923C

Our 3 drawer cart comes standard with 5" casters, all swivel with 2 locking casters. Push handle drawers, with built-in full-length pulls and hasp lock system. Yellow powder-coated steel is strong and will last for years to come. Accessories available. Dimensions: 45"H x 20"D x 31"W
Price: \$1250



4-DRAWER ISOLATION CART C-MKS-430S

This cart comes with center-pull drawer handles and comes with key lock system. Yellow powder coated steel body with wrap-around bumpers. Cart shown with optional accessories—heavy-duty railing (TRS-2), coat rack (TCR-1), and utility hooks (TUH-1). 5" casters included. Dimensions: 46½"H x 25"D x 32"W with 30" drawer space.
Cart Price: \$1049
Accessory Package \$179



FIVE EASY WAYS TO ORDER:

1. By Mail: P.O. Box 190 • Syosset, NY 11791
2. Toll-Free: 1-800-288-3547

3. By Fax: 1-516-367-4714
4. By email: LPCORP@aol.com

5. Through our website: www.LatestProducts.net



Buy 4 or more and take 5% off!

PVC PILLOW STORAGE AND TRANSPORT CART

Our C-PC-4000 cart was designed to store and transport pillows in a convenient fashion. This versatile product can hold up to 13 hospital-type pillows.

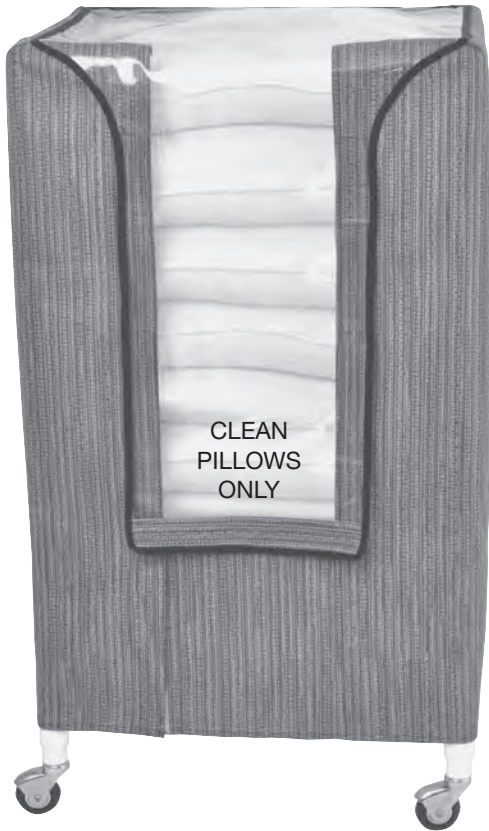

Features of this cart include:

- 3" Deluxe locking carpet master casters for easy transport on varied surfaces
- Clear protective vinyl front flap allows for quick inventory check and can flip up for easy loading and unloading
- Vinyl flap keeps contents clean and fresh
- Hospital-grade, easy to clean fabric meets California fire code regulations
- Available in 4 neutral aesthetically pleasing fabrics as well as bright yellow and our red, white and blue "Victory" line (popular with VA Hospitals)
- Dimensions of 48"H x 38"W x 21"D can hold up to 13 hospital pillows
- Fully customizable for larger or smaller capacity needs
- Optional cart identification label/lettering included
- Cart can be used for items other than pillows, such as linens, towels, blankets, isolation gowns, etc.

C-PC-4000 Model shown with "Durango" Cart Cover

\$449 per cart

Custom Units Available!

Also ideal for up to 300 ISO gowns!



Please share our catalog with other departments throughout your facility who may be interested in our products. We would be happy to send another catalog upon request.

LABORATORY SEATING

Many options available — please inquire.

Buy 6 or more!
Free Shipping
within the
Continental U.S.

Model #8501
Ergonomic Lab Chair
with Seat Tilt
\$420.00



Model #8503
Ergonomic Lab Chair
with Seat & Back Tilt
\$450.00



Model #8702
Lab Stool with
D-Handle Release
\$335.00



Model #8418
Ergonomic Chair
\$340.00



Model #9401
Urethane
Sit/Stand
\$165.00



Model #8403
Ergonomic Lab Chair
\$405.00



Model #9208
Industrial Stool
\$230.00



FIVE EASY WAYS TO ORDER:

1. **By Mail:** P.O. Box 190 • Syosset, NY 11791
2. **Toll-Free:** 1-800-288-3547

3. **By Fax:** 1-516-367-4714
4. **By email:** LPCORP@aol.com

5. **Through our website:** www.LatestProducts.net



SINCE 1972, DISTRIBUTORS OF SPECIALTY ITEMS FOR HOSPITALS, NURSING HOMES, INSTITUTIONS

LATEST PRODUCTS CORP.

P.O. Box 190 • Syosset, New York 11791 • 1-800-288-3547 • Fax 1-516-367-4714 • email LPCORP@aol.com

PHLEBOTOMY/BLOOD DRAW SEATING

Quantity discounts available — please inquire.

Many colors and options also available.

Model #6020

Ideal for
Bariatric Patients
\$450.00



Model #6010

\$410.00



Model #6005

\$270.00



PATIENT SEATING

Model #2410

Bariatric Wall Saver
\$330.00



Model #2020

Wall Saver
with Slanted Arms
\$165.00



Model #2010

Wall Saver
with Straight Arms
\$165.00



Minimum Patient Seating order is 2 chairs.
Many other styles available.

We gladly accept Mastercard, Visa and American Express.

PHYSICIAN SEATING

Quantity discounts available — please inquire.

**Buy 6 or more!
Free Shipping
within the
Continental U.S.**

Model #7408
Hydraulic
Surgical Stool
\$495.00



Model #7404
Hydraulic Surgical Stool
with Black Column
\$495.00



Model #9701-7-PA
Physician Stool
\$315.00



Model #9501
Physician Stool
\$149.00



Model #9702
Physician Stool
with Chrome Base
\$195.00



Model #9803
Stool with Full
Foot Release
\$315.00



Model #9903
Stool with Full
Hand Release
\$205.00



FIVE EASY WAYS TO ORDER:

1. **By Mail:** P.O. Box 190 • Syosset, NY 11791
2. **Toll-Free:** 1-800-288-3547

3. **By Fax:** 1-516-367-4714
4. **By email:** LPCORP@aol.com

5. **Through our website:** www.LatestProducts.net



SINCE 1972, DISTRIBUTORS OF SPECIALTY ITEMS FOR HOSPITALS, NURSING HOMES, INSTITUTIONS

LATEST PRODUCTS CORP.

P.O. Box 190 • Syosset, New York 11791 • 1-800-288-3547 • Fax 1-516-367-4714 • email LPCORP@aol.com



BED BUG & DUST MITE PROTECTION FOR MATTRESSES AND PILLOWS

BED BUGS . . . every day you read about them in the newspaper or watch a story about them on the nightly news . . . it's a growing epidemic across the country . . .

Latest Products is very pleased to announce our complete line of *bed bug protection!*

Our products are already in use by many prominent national hospitals, nursing homes, correctional facilities, hotels/motels, and colleges across the country.



Some of the features and benefits of our products are:

- Certified Bedbug Proof with the patented BugStop® Closure
- Waterproof
- Brushed silk finish
- Treated with an anti-microbial, which inhibits the growth of mold, mildew, fungi and odor causing bacteria
- Fire retardant
- Will not crack to -15°F
- Zippered covers (recommended for maximum protection) have rust-proof polyester zippers
- Electronically sealed seams
- Special sizes available upon request including 16" deep products
- Sold in case packs only

6 GAUGE VINYL ZIPPERED MATTRESS/BOXSPRING COVERS

7" Deep

Item No.	Description	Size	Price
2006	Twin Zippered	39 x 75 x 7	\$54/case of 6
3006	Full Zippered	54 x 75 x 7	\$63/case of 6
2006-4	Hospital Twin Zippered	36 x 80 x 7	\$57/case of 6
2006-2	Long Twin Zippered	39 x 80 x 7	\$59/case of 6

6 GAUGE VINYL FITTED* MATTRESS/BOXSPRING COVERS

9" Deep

Item No.	Description	Size	Price
2996	Twin Fitted	39 x 75 x 9	\$30/case of 6
3996	Full Fitted	54 x 75 x 9	\$36/case of 6
4996	Queen Fitted	60 x 80 x 9	\$43/case of 6
5996	Cal King Fitted	72 x 84 x 9	\$50/case of 6
6996	King Fitted	78 x 80 x 9	\$50/case of 6
2996-1	Hospital Twin Fitted	36 x 80 x 9	\$33/case of 6
2996-2	Long Twin Fitted	39 x 80 x 9	\$34/case of 6
3996-1	Long Full Fitted	54 x 80 x 9	\$39/case of 6

* Fitted covers do not provide total protection.

6 GAUGE VINYL ZIPPERED MATTRESS/BOXSPRING COVERS

9" Deep

Item No.	Description	Size	Price
1606	Crib Zippered	28 x 52 x 6	\$46 per case of 6
2096	Twin Zippered	39 x 75 x 9	\$56 per case of 6
3096	Full Zippered	54 x 75 x 9	\$65 per case of 6
4096	Queen Zippered	60 x 80 x 9	\$81 per case of 6
5096	Cal King Zippered	72 x 84 x 9	\$95 per case of 6
6096	King Zippered	78 x 80 x 9	\$95 per case of 6
2096-4	Hospital Twin Zippered	36 x 80 x 9	\$59 per case of 6
2096-3	Hospital XL Twin Zippered	36 x 84 x 9	\$60 per case of 6
2096-2	Long Twin Zippered	39 x 80 x 9	\$62 per case of 6
3096-1	Long Full Zippered	54 x 80 x 9	\$68 per case of 6

6 GAUGE VINYL ZIPPERED PILLOW COVERS

Item No.	Description	Size	Price
1006	Standard Zippered	21 x 27	\$24/case of 12
1007	Queen Zippered	21 x 31	\$27/case of 12
1009	King Zippered	21 x 37	\$31/case of 12



***** BED BUG SOLUTION ELITE *****

STRETCH POLYESTER KNIT MATTRESS/BOXSPRING COVERS—9" deep

- Cool and comfortable fabric with ideal protection from bed bugs, dust mites and other allergens!
- Fluid resistant
- Breathable urethane barrier
- Machine washable

Item No.	Description	Size	Price
93680Z	Hospital Twin Zippered	36 x 80 x 9	\$388/case of 12
93975Z	Regular Twin Zippered	39 x 75 x 9	\$378/case of 12
93980Z	Long Twin Zippered	39 x 80 x 9	\$388/case of 12
95475Z	Full Zippered	54 x 75 x 9	\$453/case of 12
95480Z	Long Full Zippered	54 x 80 x 9	\$486/case of 12
96080Z	Queen Zippered	60 x 80 x 9	\$535/case of 12
97880Z	King Zippered	78 x 80 x 9	\$648/case of 12
97284Z	Cal King Zippered	72 x 84 x 9	\$648/case of 12
9220Z	Std Zippered Pillow Cover	21 x 27	\$52/case of 24
9221Z	Queen Zippered Pillow Cover	21 x 31	\$59/case of 24
9222Z	King Zippered Pillow Cover	21 x 37	\$68/case of 24



Don't see what you need? Contact us — other sizes and options available.

LATEST PRODUCTS CORP.

www.LatestProducts.net 1-800-288-3547

Five Easy Ways To Order!



Mail this order form & or your purchase order:

Latest Products Corp.
P.O. Box 190
Syosset, NY 11791

Written purchase orders are preferred.
Your order is processed immediately upon receipt.



Call us toll-free at:
1-800-288-3547
Office hours:
Monday - Friday
8 am - 5 pm (EST)



Fax us at:
1-516-367-4714



E-mail us at:
LPCORP@aol.com



Through Our Website at:
www.LatestProducts.net

Quantity	Model Number	Description	Page Number	Color	Unit Price	Total Price

NO RETURNS PERMITTED WITHOUT PRIOR AUTHORIZATION.
All returns are subject to a 25% handling and restocking charge plus freight charges incurred.

Sub Total

New York: add appropriate sales tax.
(If you are tax exempt, please include your tax exempt number & certificate.)

Shipping & Handling

*Shipping & handling charges are prepaid by LPC and are added to your invoice.

TBD*

TOTAL

Terms: 2% 10 days; net 30 days.

Prices in this catalog are subject to change in the event of price increases from manufacturers.



WE GLADLY ACCEPT VISA, MASTERCARD AND AMERICAN EXPRESS.

Method of Payment:

Purchase Order Number: _____

PAYMENT ENCLOSED (OR) PLEASE CHARGE MY: Visa Mastercard American Express

Account #: _____ Expiration Date: _____ Security Code: _____

Signature: _____

3 digits on back of Visa & MasterCard
4 digits on front of American Express.

Please Ship My Order To:

Company/Institution: _____ Attention: _____

Phone: _____ Extension: _____ E-mail: _____

Shipping Address (no P.O. Boxes): Shipping Address and Billing Address are the same.

Billing Address (if shipping and billing address is different):

Please send additional catalogs to:

Thank you for your order!

Find us on Facebook!

Follow us on Twitter!



Our Satisfied Customers Say...

"I was one of Latest Product's first customers way back in 1972. I was satisfied then, and am a satisfied customer now, 40 years later!"
-B.W., New York, NY

"During these days of budget cut backs, we can always count on Latest Products to save us money. Enclosed is our newest order for hamperstands, laundry bags and linen carts."
-J.P., Atlanta, GA

"No company provides better customer service than LP! I have recommended your products to other departments and they are just as pleased. You Are The Best!"
-A.J., San Diego, CA

"We had a surprise Joint Commission inspection last year. We needed cart covers & laundry bags in a hurry. As always, LP. came through and on very short notice. Thank you LP."
-R.S., Milwaukee, WI

P.O. BOX 190
SYOSSET, NEW YORK 11791
FAX: 516-367-4714
E-MAIL: LPCORP@AOL.COM
1-800-288-3547

Prices current as of 2015. In event of continued
increase in raw materials prices are subject to change.



We are your complete source for...

- Laundry Bags
- Net Bags
- Cart Covers
- Hamperstands
- Heat Sealing Machines
- Pillows
- Utility Carts
- Indoor & Outdoor
Trash Receptacles
- Garment Racks
- Shelving Units
- Dolly Carts
- Laundry Scales
- Stainless Steel Tables
- Stainless Steel Carts
- Security Carts
- Heat Dye Transfers
& Emblems
- Privacy Screens
- PVC Carts
- Recycling Containers
- Housekeeping Carts
- Dunnage Racks
- Dump Trucks

and other hard-to-find items!

